

RADIO CRAFT

In this issue —

Automatic Selectivity Radio
A Receiver for the V. H. F.
Universal Signal Generator



RADIO CONTROLLED
TARGET AIRPLANE

SEE PAGE 247



ALEX
SCHUBURG

RADIO-ELECTRONICS IN ALL ITS PHASES

JAN

1946

25¢

CANADA 30¢

Turner Microphones

WHATEVER the need for a microphone in electronic recording, P.A., sound system, and commercial or amateur broadcast work, you can assure maximum performance when you Team Up with TURNER. Precision engineered to deliver smooth, accurate reproduction of any desired sound without harmonics or distortions . . . ruggedly built to withstand severe service conditions of shock, vibration, heat, cold, humidity and altitude, TURNER Microphones are CERTIFIED to help you select the right unit for your particular job.

Before leaving the factory, each and every TURNER Microphone is given an individual sound pressure test over the entire audio band. Its performance characteristics are checked and CERTIFIED to conform with established specification standards.

Whether you need a unit with "Weighted Response" to accent intelligible speech frequencies or a unit with an even response for general purpose use, you can depend on TURNER for accurate pick-up and clear, sharp reproduction.

Write for Free Illustrated Catalog describing TURNER Microphones for both specific and general applications. Turner Engineers will be glad to offer impartial suggestions in helping you choose the right unit for your purpose.

Certified Performance

The TURNER Company

902 17th Street, N.E., Cedar Rapids, Iowa

Licensed under U.S. Patents of the American Telephone & Telegraph Company and Western Electric Company, Incorporated.
Crystals licensed under patents of the Brush Development Company.

TURNER *Pioneers in the
Communications Field*



TURNER No. 99



TURNER Han-D



TURNER No. 33

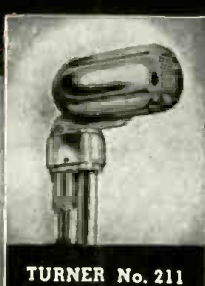

TURNER No. 211



TURNER No. L-40



Be Your Own Boss



**I WILL SHOW YOU HOW TO START
A RADIO SERVICE BUSINESS
Full Time or Spare Time WITHOUT CAPITAL**

SAMPLE LESSON FREE

J. E. SMITH, President
National Radio Institute
Our 31st Year of Training
Men for Success in Radio

Let me show you facts about rich opportunities in Radio. See how knowing Radio can give you security, a prosperous future, and let you name *your own* hours as *your own* boss in *your own* Radio business. Send the coupon for FREE 64-page book, "Win Rich Rewards in Radio." Read how you practice building, testing, repairing Radios with SIX BIG KITS OF PARTS I send you. I will also send you FREE my sample lesson, "Getting Acquainted with Receiver Servicing."

Future for Trained Men is Bright in Radio, Television, Electronics

The Radio Repair business is booming NOW. In your own spare time or full time Radio business you'll make good money fixing Radios, plus a good profit on Radio parts, and put yourself in line for more profits selling new Radios now that they can be made.

Trained Radio Technicians also find wide-open opportunities in Police, Aviation, Marine Radio, in Broadcasting, Radio Manufacturing, Public Address Systems, etc. And greater opportunities are coming, when Television and Electronics are available to the public. Send for free book now!

Many Beginners Soon Make \$5, \$10 a Week EXTRA in Spare Time

The day you enroll I start sending EXTRA MONEY JOB SHEETS to help you make EXTRA money fixing Radios in spare time while learning. You LEARN Radio principles from my easy-to-grasp lessons—PRACTICE what you learn by building real Radio Circuits, with Radio parts I send—USE your knowledge to make EXTRA money in spare time.

Find Out What N.R.I. Can Do for YOU

MAIL COUPON for sample lesson and 64-page book, both FREE. The book is packed with facts about opportunities for you. Read the details about my Course. Read letters from men I trained telling what they are doing, earning. Just MAIL COUPON in an envelope or paste it on a penny postal. J. E. Smith, President, Dept. 6AX, National Radio Institute, Pioneer Home Study Radio School, Washington 9, D. C.

I TRAINED THESE MEN



**\$35-\$45 a Week
In Own Shop**

"Previous to enrolling for your radio training I made \$12 per week in a hardware store. Now I operate my own repair shop, and often clear \$35 to \$45 a week."—FRED ERICK BELL, 76 Golf Ave., St. Johns, Newfoundland.



**Averages Over
\$60 a Week**

"Not long ago I was working 16 hours a day in a filling station at \$10 a week. Now I have my own radio business and average over \$60 a week. The N.R.I. course is fine."—ALBERT C. CHRISTENSEN, 1116 10th Avenue, Sidney, Neb.



**\$50 a Week
From Own Shop**

"Am making over \$50 a week profit from my own shop. Have another N.R.I. graduate working for me. I like to hire N.R.I. men because they know Radio."—NORMAN MILLER, Hebron, Neb.

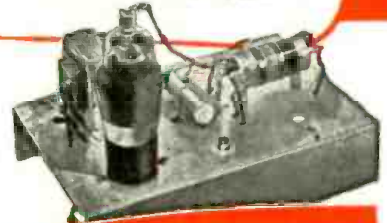

You build this A. M. SIGNAL GENERATOR that gives you valuable experience. Provides amplitude-modulated signals for test and experiment purposes.

**LEARN RADIO BY
PRACTICING
IN SPARE TIME**

with 6 Big Kits of Radio Parts I Send You



You Build this SUPERHET-ERODYNE CIRCUIT that brings in local and distant stations. You get practical experience putting this set through fascinating tests!

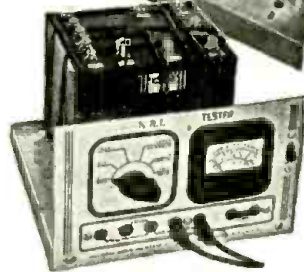

You Build this MEASURING INSTRUMENT yourself early in the course—use it for practical Radio work on neighborhood Radios to pick up EXTRA spare time money!

**GET BOTH 64 PAGE BOOK
SAMPLE LESSON FREE**

J. E. SMITH, President, Dept. 6AX
National Radio Institute, Washington 9, D. C.
Mail me FREE, without obligation, Sample Lesson and
64-page book about how to win success in Radio and
Television—Electronics. (No salesman will call. Please
write plainly.)

Age

Name

Address

City State ZIP

(Please include Post Office Zone Number)



MY COURSE
INCLUDES
TRAINING IN

Television • Electronics

RADIO-CRAFT for JANUARY, 1946

**ANOTHER IMPORTANT
FROM MAGUIRE**

FOR FASTER, BETTER AND MORE COMPLETE SERVICE
TO ALL CUSTOMERS

MAGUIRE INDUSTRIES, INC.

ANNOUNCES THE FORMATION OF ITS NEW

ELECTRONIC DISTRIBUTOR

and

INDUSTRIAL SALES DEPARTMENT

THIS NEW DEPARTMENT WILL ASSUME ALL

MERCHANDISING

SALES

and

CUSTOMER RELATION

DUTIES AND RESPONSIBILITIES ESSENTIAL IN
MARKETING THE COMBINED PRODUCTS OF THE

THORDARSON DIVISION

MEISSNER DIVISION

RADIART CORPORATION

★

★

★

**ELECTRONIC DISTRIBUTOR AND
INDUSTRIAL SALES DEPARTMENT**

ANNOUNCEMENT

INDUSTRIES, INC.

THESE SUPERIOR PRODUCTS NOW
AVAILABLE FROM A SINGLE SOURCE

THORDARSON

TRANSFORMERS

Precision engineered and quality built transformers for all requirements... replacement, communications, sound amplifier, industrial, experimental and amateur.

TRU-FIDELITY AMPLIFIERS

In new, modern designs featuring advanced tone compensation, conservative ratings, ample ventilation, low hum level, multiple input channels and maximum flexibility of controls.

 **Meissner**

COMPONENTS

Precision-built components including antenna, R. F. and oscillator coils; standard, plastic and Ferro-cart transformers; windings, coils, chokes and accessories.

SERVICE INSTRUMENTS

Meissner Analyst—operates by "signal tracing" method, fastest and most reliable—furnished complete. Signal Calibrator—a portable self-contained unit.

Radiart

VIBRATORS

Radiart Correct Replacement Vibrators are individually engineered to meet exactly the physical as well as the electrical requirements of each application.

RUST-PROOF AERIALS

A complete line of newly designed aerials to fit all cars; 3 and 4 section models—cowl, fender and under hood types... all made of finest materials.

SEE FOR YOURSELF!

See the outstanding products of the Electronic Divisions of Maguire Industries, Inc., at the Winter Meeting of the I. R. E. at the Hotel Astor, New York on January 23 to 26.

MAGUIRE INDUSTRIES, INC.

936 NORTH MICHIGAN AVENUE, CHICAGO 11, ILLINOIS

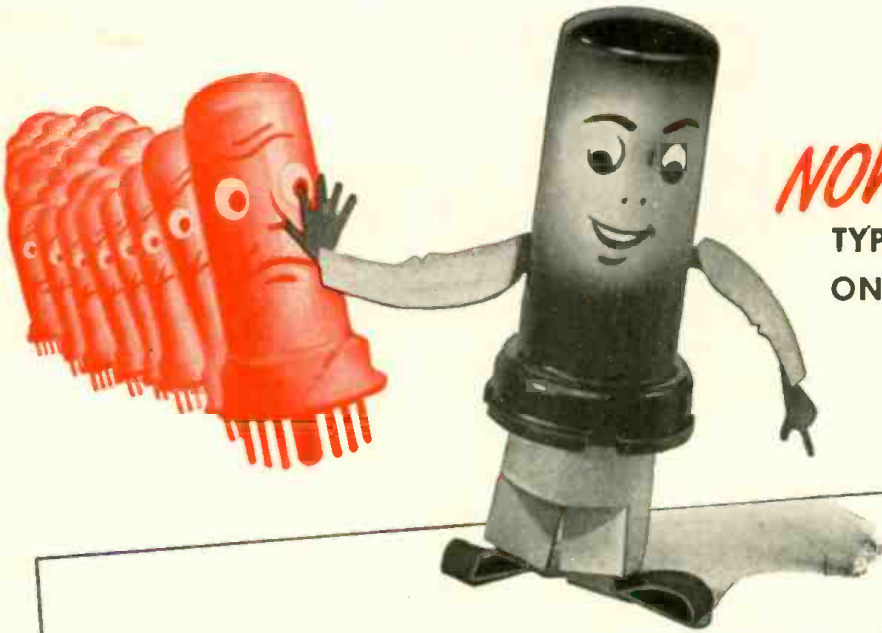

NOW- REPLACE OVER 875
 TYPES OF BALLAST TUBES WITH
 ONLY 10 N.U. UNIBALLASTS

N.U. UNIBALLAST

**COVERS YOUR REPLACEMENT NEEDS WITH
 ONLY 10 FAST-SELLING PROFITABLE TYPES**

YOU BET Uniballast are a real profit-maker for service men. With only 10 types of N.U. Uniballast to carry, you keep your investment constantly turning, and putting profits in your pocket. Order Uniballasts today from your N.U. Jobber. And ask him for the "N.U. Uniballast Service Manual" or write—National Union Radio Corporation, Newark 2, New Jersey.

SPECIFICATIONS

- Uniballast—the universal ballast tube—small—compact—easy, quick installation.
- Metal envelope is excellent heat radiator. "Plug-in" simplicity.
- Provides proper operating current conditions regardless of variations in line voltage and in the characteristics of tube heaters and pilot lights.
- Even if one or more pilot lights burn out Uniballast continues to operate the tube filaments in the string, at efficient current range.
- Resistance is self-compensating—adjusts itself automatically—true ballast action. Voltage dropping range is indicated on every Uniballast.

NATIONAL UNION RADIO TUBES AND PARTS

*Transmitting, Cathode Ray, Receiving, Special Purpose Tubes • Condensers •
 Volume Controls • Photo Electric Cells • Panel Lamps • Flashlight Bulbs*



Actual size
 Ov. Length 3 1/4"
 Seated Ht. 2 1/8"
 Diameter 1"

Order Today from your N.U. Jobber

I'LL SHOW YOU HOW TO SUCCEED IN RADIO

Here's the right training for Big Post-War Pay!



A RADIO SERVICE BUSINESS OF YOUR OWN

A GOOD JOB IN RADIO & TELEVISION BROADCASTING

RADIO-ELECTRONIC SERVICE ENGINEER



F. L. Sprayberry, one of the country's foremost Radio Teachers.

BE A RADIO ELECTRONICIAN

NOW! YOU CAN PREPARE AT HOME IN YOUR SPARE TIME FOR THE AMAZING OPPORTUNITIES AHEAD IN RADIO — ELECTRONICS — TELEVISION

The offer I make you here is the opportunity of a lifetime. It's your big chance to get ready for a wonderful future in the swiftly expanding field of Radio-Electronics INCLUDING Radio, Television, Frequency Modulation and Industrial Electronics. Be wise! NOW'S the time to start. Opportunities ahead are tremendous! No previous experience is necessary. The Sprayberry Course starts right at the beginning of Radio. You can't get lost. It gets the various subjects across in such a clear, simple way that you understand and remember. And, you can master my entire course

in your spare time. It will not interfere in any way with your present duties. Along with your Training, you will receive my famous BUSINESS BUILDERS which will show you how to make some nice profits while learning.

Prepares You for a Business of Your Own or Good Radio Job

My training will give you the broad, fundamental principles so necessary as a background, no matter which branch of Radio you wish to specialize in. I make it easy for you to learn Radio Set Repair and Installation Work. I teach you how to install and repair Electronic Equipment. In fact, you'll be a fully qualified RADIO-ELECTRONICIAN, equipped with the skill and knowledge to perform efficiently and to make a wonderful success of yourself.



I SUPPLY A FULL RADIO SET for practical easy LEARNING

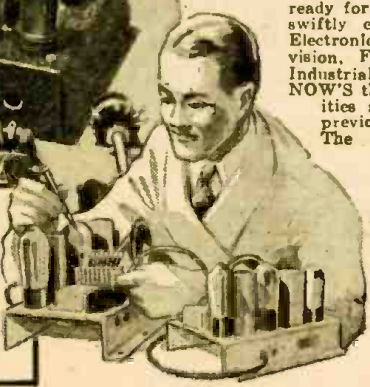

SPRAYBERRY TRAINING GIVES YOU BOTH TECHNICAL KNOWLEDGE • SKILLED HANDS

There's only one right way to learn Radio Electronics. You must get it through simplified lesson study combined with actual "shop" practice under the personal guidance of a qualified Radio Teacher. It's exactly this way that Sprayberry trains you . . . supplying real Radio parts for learn-by-doing experience right at home. Thus, you learn faster, your understanding is clear-cut, you acquire the practical "know how" essential to a good-paying Radio job or a Radio business of your own.

ods, you do not have one cent of outlay for manufactured Test Equipment which is not only expensive but scarce.

Read What Graduate Says "One Job Nets About \$26.00"

"Since last week I fixed 7 radios, all good-paying jobs and right now I am working on an amplifier system. This job alone will net me about \$26.00. As long as my work keeps coming in this way, I have only one word to say and that is, 'Thanks to my Sprayberry training' and I am not afraid to boast about it."—ADRIEN BENJAMIN, North Grosvenordale, Conn.

DON'T PUT IT OFF!

Get the facts about my training—now! Take the first important step toward the money-making future of your dreams. All features are fully explained in my big, illustrated FREE Catalog which comes to you along with another valuable FREE book you'll be glad to own. Mail Coupon AT ONCE!

Just Out! FREE!

"How to Read Radio Diagrams & Symbols" . . . a valuable new book which explains in simple English how to read and understand any Radio Set Diagram. Provides the quick key to analyzing any Radio circuit. Includes translations of all Radio symbols. Send for this FREE book now, and along with it I will send you another big FREE book describing my Radio-Electronic training.



GET FREE BOOKS

SPRAYBERRY ACADEMY OF RADIO

F. L. Sprayberry, Pres.
Room 2016
Pueblo, Colorado

Please rush my FREE copies of "HOW TO MAKE MONEY IN RADIO, ELECTRONICS and TELEVISION," and "HOW TO READ RADIO DIAGRAMS and SYMBOLS."

Name Age

Address

City State

Tear off this coupon, mail in envelope or paste on penny postcard.

RADIO CRAFT

AND POPULAR ELECTRONICS

Incorporating
SHORT WAVE CRAFT TELEVISION NEWS
RADIO & TELEVISION



HUGO GERNSBACK, *Editor-in-Chief*
FRED SHUNAMAN, *Associate Editor*
I. QUEEN, *Editorial Associate*
ELMER FULLER, *Shortwave Editor*
E. A. WITTEN, *Technical Editor*
A. PASCALE, *Production Manager*
G. ALIQUO, *Circulation Manager*
JOHN J. LAMSON, *Advertising Director*
ALFRED STERN, *Promotion Manager*

IN THE NEXT ISSUE

Electronic Transients
Reducing Hum Levels
A Capacity Bridge
Tuner-P.A. Amplifier

Published by Radcraft Publications, Inc.
Publication Office: 29 Worthington Street, Springfield 3, Mass.
Editorial and Advertising Offices: 25 West Broadway, Tel. RE2-9690, New York 7, N. Y.
Chicago Advertising Office: Radio-Craft, 308 W. Washington Street, Suite 1413, Chicago 6, Ill. Tel. Randolph 7868.
Cleveland Advertising Office: 405 Erie Bldg., Cleveland, Ohio. Burdette Phillips, Manager. Tel. Main 9645.
Los Angeles Advertising Office: 606 South Hill Street, Los Angeles 14, Calif. Ralph W. Harker, Manager.
San Francisco Advertising Office: 582 Market St., San Francisco 4, Calif. Ralph W. Harker, Manager. Tel. Garfield 2481.
New England Office: Bridgewater, Conn., W. D. Ward, Manager.
Michigan Advertising Office: 70 Highland Ave., Highland Park 3, Michigan. Harry R. Lipson, Manager.
RADIO-CRAFT is published monthly on the 25th of the month preceding that of date. Subscription rates: United States and possessions, Mexico, Central and South American countries, \$2.50 a year, \$4.00 for two years, \$6.00 for three years. Canada, \$3.00 a year, \$5.00 for two years, \$7.50 for three years. All other foreign countries, \$3.25 a year, \$5.50 for two years, \$8.25 for three years. Special rates for members of the Armed Forces in U. S., or those addressed by A.P.O. or F.P.O. mail, \$2.00. Entered at the post office at Springfield as second-class matter under the Act of March 3, 1879. All communications about subscriptions should be addressed to: Circulation Manager, Radio-Craft, 29 Worthington St., Springfield 3, Mass.

Notice of CHANGE of ADDRESS should reach us at least one month in advance. When ordering a change, please furnish an address stencil impression from a recent wrapper if you can. Address changes cannot be made without the old address as well as the new.

Foreign Agents

London—Atlas Publishing and Distributing Co., Ltd., 18 Bride Lane, Fleet St., London, E.C. 4.
Melbourne—McGill's Agency, 179 Elizabeth St., Australia.

Text and illustrations of this magazine are copyright and must not be reproduced without permission of the copyright owners. Copyright, 1945, Radcraft Publications, Inc.

Contents January, 1946 Volume XVII, No. 4

Editorial: So You Want A Radio Position!	by Hugo Gernsback	233
Radio-Electronics Monthly Review		234

ELECTRONICS

Loran-Radio Navigation Aid	by E. F. Bissie	236
Radio on Bus Lines	by S. R. Winters	238
Radio Target Planes		242
Shortwave Diathermy	by Jonathan M. Oxley	245
Elements of Radar, Part II	by Jordan McQuay	246

SERVICING

Radio Opportunities	by E. A. Witten	247
Service Sans Instruments	by Virgil R. Sears	248
A. C. Voltage Measurements	by Oscar E. Carlson	250

CONSTRUCTION

144-MC Radio	by I. Queen	239
A.S.C. Radio	by E. Aisberg	240
Portable Phono-Radio	by John F. Millar	265

SOUND

Hi-Fi Amplifier Contest	by J. W. Straede	249
-------------------------------	------------------	-----

TEST INSTRUMENTS

Signal Generator Covers All Bands	by Bob White	243
---	--------------	-----

DEPARTMENTS

World-Wide Station List	by Elmer R. Fuller	252
Radio-Electronic Circuits		256
New Radio-Electronic Devices		262
Try This One!		264
The Question Box		266
New Radio Patents	by I. Queen	274
Technotes		282
Available Radio-Electronic Literature		285
Communications		288
Book Reviews		289

ON THE COVER

A radio-controlled target airplane, or drone, is shown on this month's cover. Developed by both Army and Navy, these planes gave our servicemen valuable anti-aircraft training under conditions almost duplicating those met in actual combat



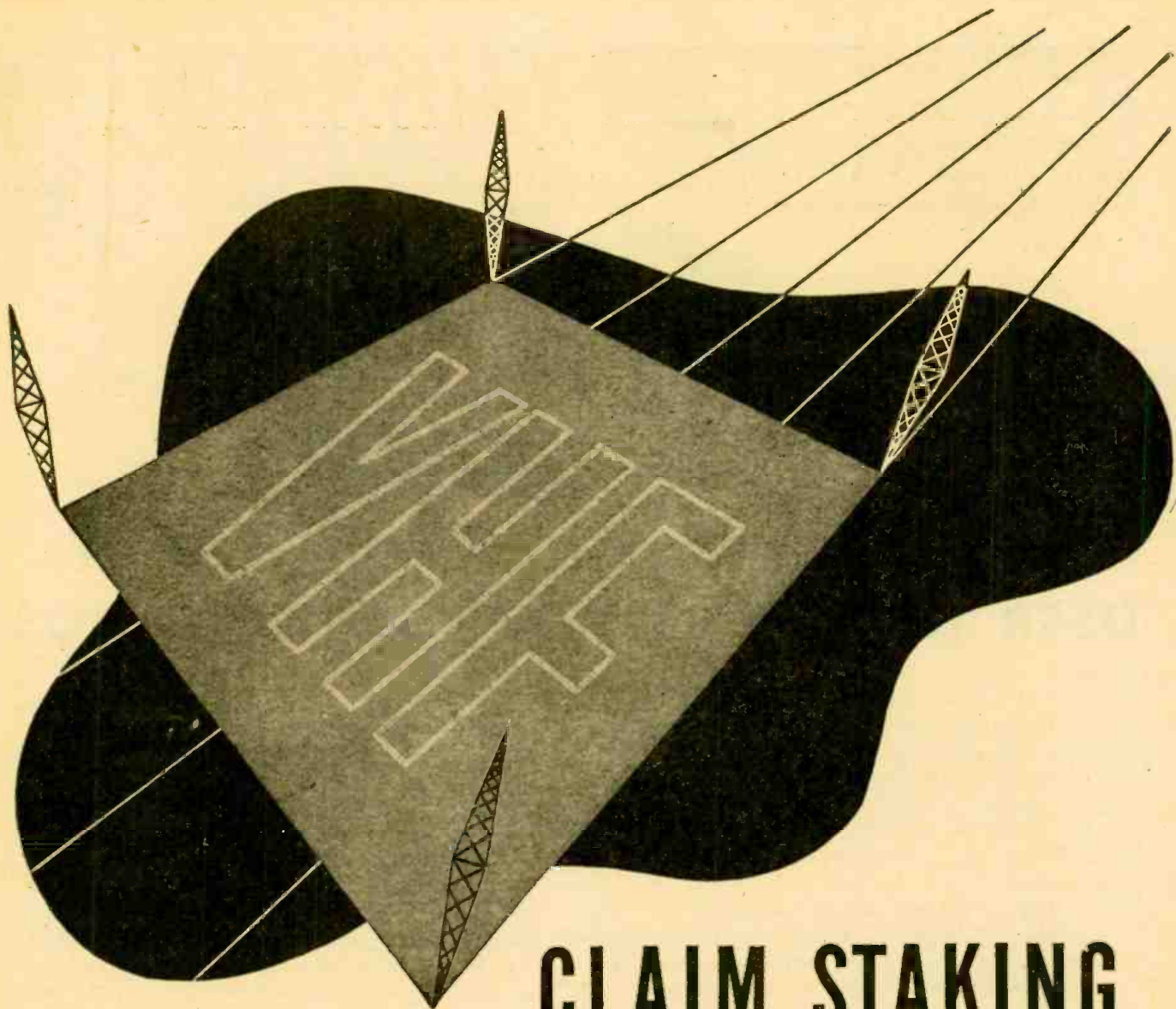

CLAIM STAKING

Hallicrafters and Very High Frequency

Based on the facts in the case, Hallicrafters can stake out a very strong claim to leadership in the very high frequency field. The facts include such things as the Model S-37, FM-AM receiver for very high frequency work. The Model S-37 operates from 130 to 210 Mc.—the highest frequency range of any general coverage commercial type receiver.

Hallicrafters further supports its claim to domination in the high frequency field with the Model S-36A, FM-AM-CW receiver. The 36A operates from 27.8 to 143 Mc., covers both old and new FM bands and is the only commercially built receiver covering this range.

Further developments in this direction can soon be revealed—adding further support to Hallicrafters claim to continued supremacy in the high frequency field.

HALLICRAFTERS NEW \$600,000 HOME NOW UNDER CONSTRUCTION.



hallicrafters RADIO



THE HALLICRAFTERS CO., MANUFACTURERS OF RADIO AND ELECTRONIC EQUIPMENT • CHICAGO 16, U. S. A.

COPYRIGHT 1945 THE HALLICRAFTERS CO.

SPRAGUE TRADING POST

A FREE Buy-Exchange Service for Radio Men



A PERSONAL MESSAGE TO EVERY USER OF THE SPRAGUE TRADING POST

With the gradual reappearance on the market of peacetime radio parts and equipment, it becomes obvious that the four-year-old Sprague Trading Post has outlived its usefulness. Rather than buy old materials, you will want factory-fresh new ones. Instead of trading obsolete equipment, you will now want to avail yourself of the many developments that wartime engineering has produced.

Thus, we are sure that the thousands of radio men, amateurs, experimenters, instructors and those in the nation's armed forces who have benefited through this free buy-trade-sell advertising service will fully understand our reasons for discontinuing it with the December issues of the six leading radio magazines wherein it has appeared.

In closing this chapter of Sprague cooperation with our friends throughout Radio, it is interesting to recapitulate briefly:

During the life of the Sprague Trading Post, approximately 12,000 individual classified advertisements were run absolutely free of charge. As a result, hard-to-get equipment was made rapidly available through those who no longer had need for it. Tubes, test equipment, manuals, receivers, transmitters, and dozens of other items including complete service shops were bought, sold and exchanged in tremendous quantity. So many ads were sent in to us that, on several occasions, we

* Trademark Reg. U. S. Pat. Off.

had to increase our advertising budget in order to buy enough magazine space in which to accommodate them all. All told, we invested over \$70,000.00 to make this special wartime service as effective as was humanly possible.

What does the Sprague Products Company expect to get out of all of this? Well, the answer to that one is easy. It is simply that we believe that anything we can do to help our friends is good business for us. Now that Sprague Capacitors, *Koolohm Resistors and Test Equipment are again becoming available in complete lines, we believe we can count on the loyal support of every radio man we tried to help when the going was tough. We believe we can count on you to use Sprague materials wherever possible—and if you do, we assure you that you will be getting the best, most dependable units money can buy.

Meanwhile, should any new opportunity for a cooperative service such as the Trading Post present itself, you can count on Sprague to render it to the utmost. Not only this, but I'll personally welcome suggestions and correspondence along this line from all of you who have benefited even a little through the Sprague Trading Post effort during the hectic wartime years.

Harry Kalker
SALES MANAGER

SPRAGUE PRODUCTS CO., NORTH ADAMS, MASS.



CAPACITORS FOR EVERY SERVICE, AMATEUR AND EXPERIMENTAL NEED

MARKET FOR 100 MILLION RADIOS REVEALED BY SYLVANIA SURVEY
 OVER FIVE- OR SIX-YEAR PERIOD, RESULTS SHOW
 Radio-Phonographs Found Popular

BENDIX REVEALS PLANS TO DEVELOP SALES OF PERSONAL PLANE RADIO

RADIO AND TELEVISION "BOOM" IS ENVISIONED BY SENATE COMMITTEE

Reconversion and Jobs In the Radio Industry

RADAR TO GUIDE FUTURE TRAVEL

RADIO INDUSTRY FACES BRIGHT FUTURE

**FOR REAL
 JOB SECURITY
 NOW AND
 IN THE FUTURE..**

Learn RADIO ELECTRONICS
 AT HOME OR IN OUR CHICAGO LABORATORIES
DeFOREST'S MODERN A-B-C WAY!

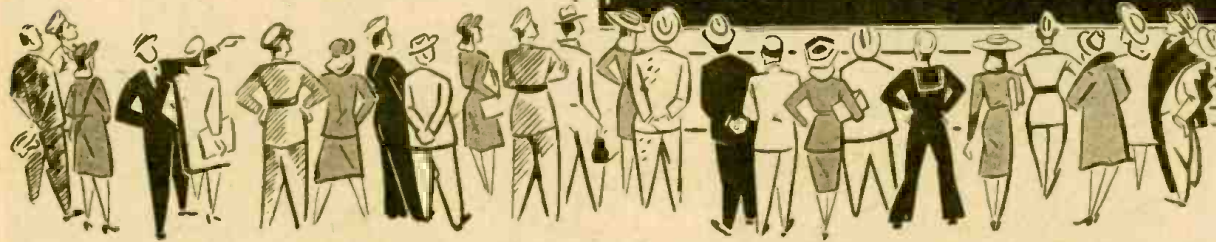

Are you looking for job security and good pay? Take a look at today's headlines! You'll see that the billion dollar Radio-Electronic field offers some of America's most promising present and future opportunities. Think of the opportunities ahead in F. M. Radio, Broadcast Radio, Radio Sales and Service, Two-Way Train Radio, Motion Picture Sound, Aviation Radio, a Radio Business of Your Own, Electronics, etc. Here's a field that's wide awake—that's full of action, opportunities for advancement—fascinating work.

home training advantages of actual MOVIES and "Synco-Graphic" Lesson Texts, prepared under the supervision of Dr. Lee DeForest, the "Father of Radio," actually help make learning faster-easier . . . and much more enjoyable, more interesting. The 133 fascinating experiments, which you make with the 8 Big Kits of Radio Parts and Assemblies you use, give you practical "Shop Training" right in your own home.

YOU GET EMPLOYMENT SERVICE, TOO

When you complete DeForest's Training you get the help of DeForest's Effective Employment Service to help you get started in this billion-dollar ELECTRONIC opportunity industry . . . to help line you up for a good job. Mail coupon NOW for complete information—get the big "Victory for You!" book and Equipment folder—see how easy it is to get started at once. No obligation. Note: Complete Residential Training is available in our Modern Chicago Laboratories shown at left . . . ask about it! Mail coupon today, sure!



- ONLY DeFOREST'S PROVIDES ALL THREE HOME TRAINING AIDS**
- A** DeVRY MOVIE PROJECTOR AND LEARN-BY-SEEING FILMS
 - B** ACTUAL RADIO PARTS TO WORK OUT EXPERIMENTS
 - C** 90 lessons prepared under the supervision of Dr. Lee DeForest.

If you are even slightly mechanically minded . . . if you can follow clear, easy-to-understand instructions—you can learn all about Radio-Electronics and its many applications in Industry, Radar, FM, Fac-Simile, etc. De Forest's Modern A-B-C Method simplifies learning! The exclusive DeForest's

DeFOREST'S TRAINING INCLUDES INSTRUCTION IN MOTION PICTURE SOUND EQUIPMENT, FM RADIO AND TELEVISION . . .

E. B. DeVry, President
 DeFOREST'S TRAINING, INC.
 2535-41 North Ashland Ave., Dept. RC-C1
 Chicago 14, Illinois, U.S.A.

Please send me your "VICTORY FOR YOU!" BOOK and EQUIPMENT FOLDER

Name _____ Age _____
 Address _____
 City _____ Zone _____ State _____
 If under 18, check here for special information. If a discharged veteran of World War II check here.

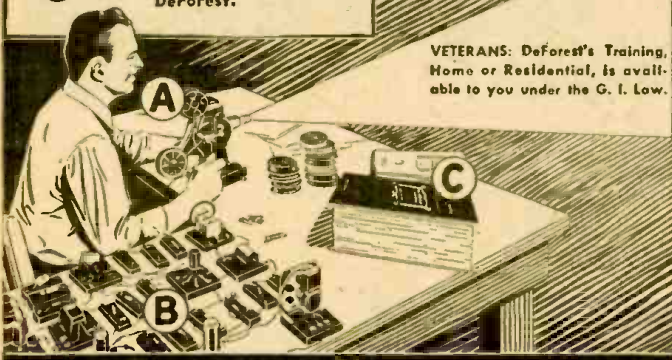

VETERANS: DeForest's Training, Home or Residential, is available to you under the G. I. Law.

DeFOREST'S TRAINING, INC.
 CHICAGO 14, ILLINOIS

The Curtain is Rising

on the most sensational development, hitherto undreamed of, in amateur radio history! There isn't a "ham" operator in the United States, or in the entire world for that matter, who won't be interested in knowing what is behind this curtain. Watch for the Kluge advertisements to follow.

The Kluge secret will soon be
a reality



1031 N. ALVARADO • LOS ANGELES 26, CALIF.

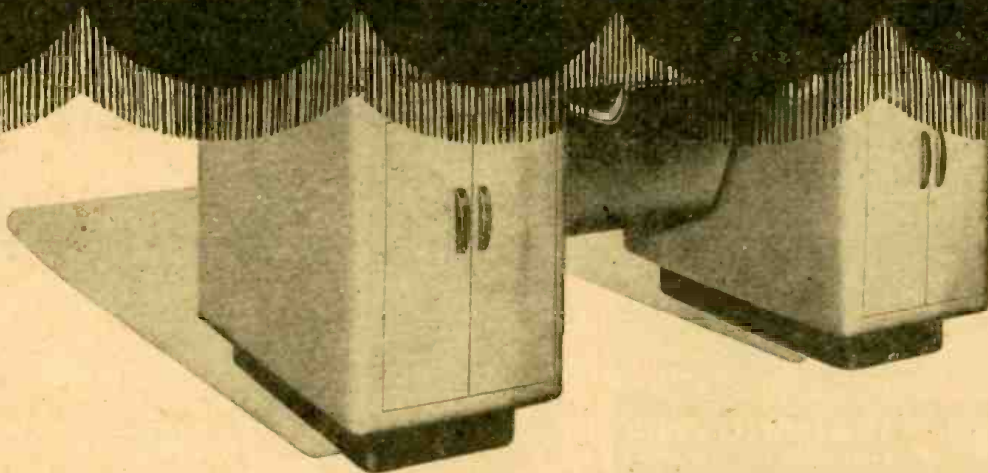

MAKE MORE MONEY

IN Radio TELEVISION & ELECTRONICS

Now!

GET THESE 2 BIG BOOKS

FREE!

You men already in Radio know how great the demand is for trained, experienced servicemen, operators and technicians. You know how fast the field is growing and how important it is to keep up with developments — F.M. Receivers, Electronics and Television. You know, too, a fellow cannot learn too much about any industry for **REAL SUCCESS**. Whether you have experience or are merely **INTERESTED** in radio as an amateur, you must recognize the **WONDERFUL OPPORTUNITY** right within your grasp to cash in on your natural abilities. Make them pay dividends. Get into the **EXPERT RADIO SERVICE FIELD**. Be an F.M. and **TELEVISION specialist—OWN A BUSINESS OF YOUR OWN**, if you prefer. Fill out and mail the coupon below for all the details of our plan.

Here's Just a Few of the Interesting Facts you Learn with the **FREE MANUAL**.

1. Routine for diagnosing Radio Troubles.
2. Preliminary Inspection of Receivers.
3. How to Check Power Supply.
4. How to Identify Various Stages of Receiver.
5. How to Trace the Circuit and Prepare Skeleton Diagram.
6. How to Test and Measure Voltages.
7. How to Test Speaker in Audio Stages.
8. How to Test Detector, I.F., R.F., and Mixer Stages.
9. Complete Reference Table for Quickly Locating Receiver Troubles.

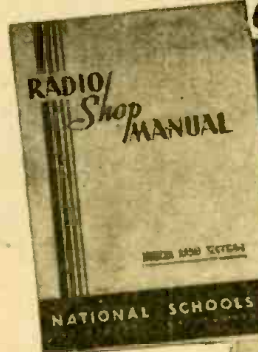

Get the Latest Inside Information—Short Cuts—Trade Secrets by

SHOP METHOD HOME TRAINING

FROM A REAL ESTABLISHED RESIDENT SCHOOL

Now the famous National Schools brings its exclusive Shop-Method of training right into your own home. You can learn the most up-to-date, approved projects, systems and circuits step by step in your spare time. This is the sound practical training you want and need—the development of experienced instructors working with thousands of students right in shops, NEW F.M. broadcast studios and experimental laboratories of **NATIONAL SCHOOLS**—one of the most advanced trade educational centers in the world.

National Trained Men Now Making the Best Money in History

The real value of National training shows up on the quick progress our men make on the job.

Incomes that seemed fantastic only a short time ago are now being reported by National graduates. And this is only a sample of what the future holds for the **MAN WHO KNOWS RADIO, ELECTRONICS, F.M. TELEVISION** and allied subjects. National is proud of the progress its graduates are making all over the world. Read the facts—the actual proof in the books we send you **FREE**.



LEARN BY DOING

Work with Real Experimental Equipment Furnished without Extra Cost as Part of Your National Training

Experience is the best teacher. You learn by experience with the exclusive National Shop-Method of Home Training. In the course of your study you actually build various types of receivers—a powerful superheterodyne, a signal generator, an audio oscillator and others—you make tests and conduct experiments that show you the why and how of things. You understand what makes the various elements of electronics operate because you actually see them work for you. Not only do you gain marvelous experience by this method of learning but you receive valuable equipment you will use on the job in the practice of your profession as an electronics expert. Mail the coupon and learn what this means to you.

Send the Coupon and prove to yourself what YOU can do in RADIO!

Be Sure Of Your Success And Security After The War

Don't let your post-war ambitions lag. Don't let YOUR future depend on others. Build a career for yourself. Never in all history has the returning serviceman, or war worker been confronted with such a great future if he reaches out and grasps it NOW. Here is a new world opening before you. Get ready now while you are still in uniform—while you are on your war job. Then you can soon step into an essential, well paid position or, with little capital, **GET INTO BUSINESS FOR YOURSELF**. It isn't a bit too soon to start now. Radio men are vitally needed. Fill out and mail the coupon immediately and examine the **NATIONAL SHOP METHOD HOME TRAINING COURSE** carefully, without obligation.

FREE LESSON INCLUDED

Examine the exclusive National Shop Method of Home Training. See for yourself how sound and practical it is. Be convinced that you can learn Radio, Electronics, Television—quickly and easily in your spare time. You can't tell until you try. This trial is **ABSOLUTELY FREE**. Fill out the coupon immediately while you are thinking about it and drop it in the mail.

Mail the coupon here for the books that tell you the complete story of the marvelous new system of training in Radio, Electronics and Television. Learn the facts of this exclusive shop-method of home training. See for yourself **DECIDE FOR YOURSELF!**

This is the **MODERN SYSTEM OF TRAINING**: It matches the rapid progress constantly being made in Radio, Television and Electronics. It is **TIME TESTED**, too. National Schools has been training men for more than a third of a century. It is the very same training that has helped thousands to more pay and greater opportunity.

You owe it to yourself—your future—to read the book "Your Future in Radio, Electronics and Television"—**FREE** to you when you send in the coupon.

NATIONAL SCHOOLS

LOS ANGELES 37, CALIFORNIA EST. 1905

MAIL OPPORTUNITY COUPON FOR QUICK ACTION

National Schools, Dept. RC-1

4000 South Figueroa Street, Los Angeles 37, California.

Mail me **FREE** the two books mentioned in your ad, including a sample lesson of your course. I understand no salesman will call on me.

NAME AGE

ADDRESS

CITY STATE

Include your zone number

Learn RADIO- ELECTRONICS- TELEVISION



ELECTRONIC CIRCUIT TESTING — Instructor showing students use of large Cathode Ray Oscilloscope.

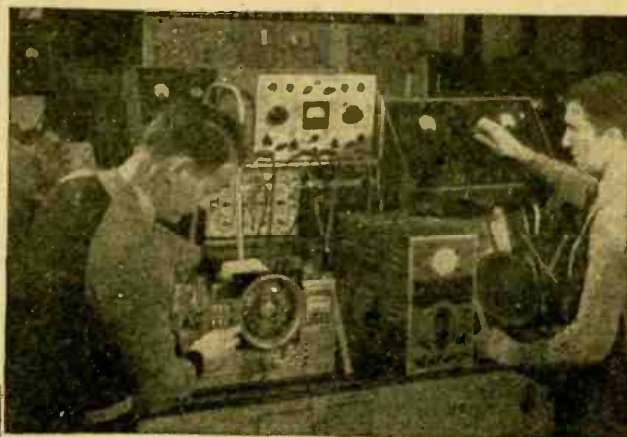

RADIO TESTING AND SERVICING—Students learning to locate troubles with modern radio analyzers.

**TRAIN FOR A GOOD
JOB NOW** *one that*
offers STEADY WORK
with a **REAL FUTURE**

Don't be caught napping. Prepare for a good job now that will still be a good job with a real future when conditions change. If you are not a trained man you may have to compete with millions of other untrained men. Get into a field that offers real opportunities in good-times and bad-times. Tremendous expansion in Frequency Modulation and Television is predicted because of war time discoveries now being re-converted to civilian use. Radio-Electronics trained men are needed today—they will be needed in the years ahead!

"Learn by Doing"

RIGHT HERE in the SHOPS of COYNE—12 Weeks Training
Student Finance Plan

We train you on real Radio, Television and Sound equipment—RIGHT HERE IN THE COYNE SHOPS IN CHICAGO. Whether or not you have had Radio experience you need Coyne all-around Radio Electronics training. Many of my students had no previous experience. Others had experience in one or two branches but realized they needed all-around training for better jobs and advancement.

EARN WHILE LEARNING

If you need part-time work to help pay living expenses while at school, we will help you get it. Coyne graduates also receive a Life Membership with Lifetime Employment Service, free technical service and privilege of review without additional tuition charge.

MEN WITH PHYSICAL DISABILITIES—whether due to war or other causes—we also have facilities for you. Check coupon for particulars if you have a physical disability of any nature.

H. C. Lewis, Pres.

COYNE **ELECTRICAL SCHOOL**
RADIO-ELECTRONICS DIV.

500 So. Paulina Street Dept. 16-8H, CHICAGO 12, ILLINOIS

PREPARE FOR JOBS LIKE THESE

Frequency Modulation (FM)
Radio Manufacturing
Radio Set Serviceman
Television Servicing
Electronics Maintenance
Public Address Systems, etc.
Your Own Radio Shop

**EXTRA
TRAINING**
NO EXTRA COST

Industrial Electronics
and Electric Refrigeration
Extra training to help
you get ready for the
better jobs in these great
fields . . . no additional
tuition cost IF YOU
ACT NOW!

THE HOME OF
COYNE



VETERANS!
Coyne is also
equipped to
train those
who qualify
for training
under the
G. I. Bill of
Rights.
Check coupon
for special
G. I. Bulletin.

Real Opportunities for the Radio Trained Man

Prepare for jobs as assembler, inspector and tester—Radio sales or service and installation work, electronics, television, sound work, aircraft-radio, auto-radio, etc. Many opportunities in the vast Radio-Electronics field.

GET MY BIG NEW BOOK

It tells all about my big Chicago shops and my plans to help you get ahead. Packed with facts and pictures of students at work in my shops. Mail coupon for this Big New Book now! Coupon will also bring details on how I'll Finance Your Training . . . facts on how I help you "Earn-While-Learning" . . . information on FREE EMPLOYMENT SERVICE FOR LIFE . . . and other plans to help you. **ACT NOW TO MAKE SURE YOU GET MY GENEROUS OFFER.** Sending for this interesting free book can be your first big step to success. No obligation. No salesman will call. Mail coupon today.



H. C. Lewis

■ H. C. LEWIS, Pres., Radio-Electronics Div.,
■ COYNE ELECTRICAL SCHOOL
■ 500 S. Paulina St., Dept. 16-8H,
■ Chicago 12, Ill.

■ Dear Mr. Lewis: Send me your Big Free
■ Radio-Electronics Book and all the facts . . .
■ also full details of your "Student Finance"
■ plan. Send special G. I. Bulletin.
■ Send physical disability details.

NAME.....

ADDRESS.....

CITY.....STATE.....

So You Want a Radio Position!

... All too often applicants for a position forget that they are selling a commodity—a very expensive one; namely, labor and—themselves. . . . In this highly competitive field there are certain musts, certain rules, which all too often are overlooked. . . .

HUGO GERNSBACK

A FEW weeks ago, we inserted an advertisement in a local paper to fill a vacancy in our organization. In due time a rather large amount of letters were received through which we plowed with zest.

Since Pearl Harbor the returns to any type of advertisement have been few and far between. Now with the returning military, conditions have improved to such an extent that employers nowadays are in a position to get exactly the type of worker they want. This nation-wide competition of applicants is likely to become more intense as time goes on.

As we went from letter to letter we became appalled at the lack of common sense of most applicants, who did not have the most elementary understanding how to proceed when applying for a more-or-less important position. Eighty percent of the missives immediately went to the waste-paper basket, which we shall identify hereafter with the symbols of WB. Twenty percent of the remaining letters, after a second careful reading, melted down to 3% of all the applications. To these few letters were dispatched asking the candidates to arrange for an interview.

We are not alone in our contention that most applicants today violate every established rule in looking for a position; other radio officials whom we interviewed speak of it with equal distress. They, too, are appalled at the tremendous waste of energy and time of applicants writing letters, telegrams, postal cards, and other communications when trying to obtain a position in radio today.

The greatest violation is found in the careless reading of the prospective employer's advertisement. Many applicants skim heedlessly over the want ads and answer without seeming to have the remotest idea of what the requirements are all about. The upshot is that when a radio manufacturer recently inserted an advertisement for a radio man who was to prepare technical booklets concerning his products, this is what happened:

Over 85% of the answers came from persons who knew nothing whatsoever about technical radio. The majority of the letters referred to scripts for radio broad-

cast purposes. It would seem that there are literally millions of people, male and female, out to make easy money in writing radio broadcast skits, which have no connection whatsoever with technical writing.

If the applicant had read the advertisement carefully, he or she would never have written a lengthy letter of application, which promptly went into the WB. We shall attempt here to classify what is wrong, and what is correct for applicants seeking radio positions today.

1. *Careless Readers of Want advertisements* must be placed first on the list. See above.

2. *The Scrawler*. When a man tries to sell a valuable commodity, the presentation should be perfect. In a highly competitive market the better and the more business-like a presentation, the more attention the letter will be given. The scrawler is an individual who takes a piece of scrap paper and scrawls on it a few hieroglyphics, blithely forgetting that no one but he can decipher it. When there are hundreds of letters to be read, no official or employment manager will attempt to decode illegible handwriting. WB for that one.

3. *The Postal Card Applicants*. This is another violation, and while a postal card is small enough to make the message brief, usually not enough information can be given. Furthermore, most postal card writers use handwriting which cannot be read too well either. There may be exceptions to postal card applications, but most employers frown on them.

4. *Lengthy Applications*. When a letter of application is well typed, is clean and paragraphed in such a way that by merely skimming through, one can get the highlights of the applicant's past experience, etc., a lengthy three or more page application may be in order. Usually, however, it is best to keep it to a maximum of three pages.

Too lengthy a letter becomes unwieldy and is usually put aside for a second reading, thereby automatically diminishing the chances of a final reading. This may never take place if too many good applicants are being considered.

5. *Writing in General*. If a letter of application is handwritten, the writing (Continued on page 251)

Radio Thirty-Five Years Ago

In Gernsback Publications

FROM the January, 1911, issue of MODERN ELECTRICS:

Apparatus for Demonstration of Wireless Telephone, by *Dr. Erich F. Hutch*.

Unique Wireless Submarine Installation, by *Frank C. Perkins*.

Wireless Institute.

Unique Radiphone Arc.

Spark Intensifier.

New Loose Coupler.

HUGO GERNSBACK	
Founder	
Modern Electrics	1908
Electrical Experimenter	1913
Radio News	1919
Science & Invention	1920
Radio-Craft	1929
Short-Wave Craft	1930
Wireless Association of America	1908

Some of the larger libraries in the country still have copies of Modern Electrics on file for interested readers.

Wireless Torpedo Control.
Wireless in Department Store.

Construction of a 50-Watt Laboratory Transformer, by *Charles F. Frassa, Jr.*

Unique Variable Condenser.

A Novel Rotary Condenser, by *M. H. Hammerly*.

Loose Coupler Test.

Effect of Winter Upon Wireless Wave Propagation, by *George F. Worts*.

RADIO DIRECTION finders combined with radiosonde will become one of modern aviation's greatest aids to safe, faster and more dependable air travel and to weather forecasting, declared B. Ray Cummings, of Farnsworth Radio and Television Corporation, last month.

Present radiosondes indicate air pressure and humidity, but are not over-reliable, as there is some uncertainty as to both barometric and altitude readings, which must both be obtained from the single air-pressure instrument. Wind direction has been observed by following the balloon, as long as it remained in sight, with a theodolite, and checking angle against assumed altitude.

The new direction finder designed and put into use by the Army in cooperation with Farnsworth engineers follows the little radiosonde balloon from the time of its ascension, providing accurate data on its position and altitude. Thus wind direction at different altitudes—extremely important to both aviation and weather forecasting—is determined exactly for distances greater than were possible with the optical system, and with a greater degree of accuracy. The system also works in fog, haze or cloudy and stormy weather where optical methods are useless.

The equipment consists of three units:

1. The balloon with radiosonde and parachute.

2. The SCR-658 direction finder, which is the most accurate built to date, having an azimuthal and elevation angle accuracy of approximately .05 degrees.

3. The radiosonde recorder unit.

Other parts include the power supply, hydrogen generator and miscellaneous accessories. The equipment operates on 397 mc.

Data from this equipment can assist the commercial meteorologist just as it aids

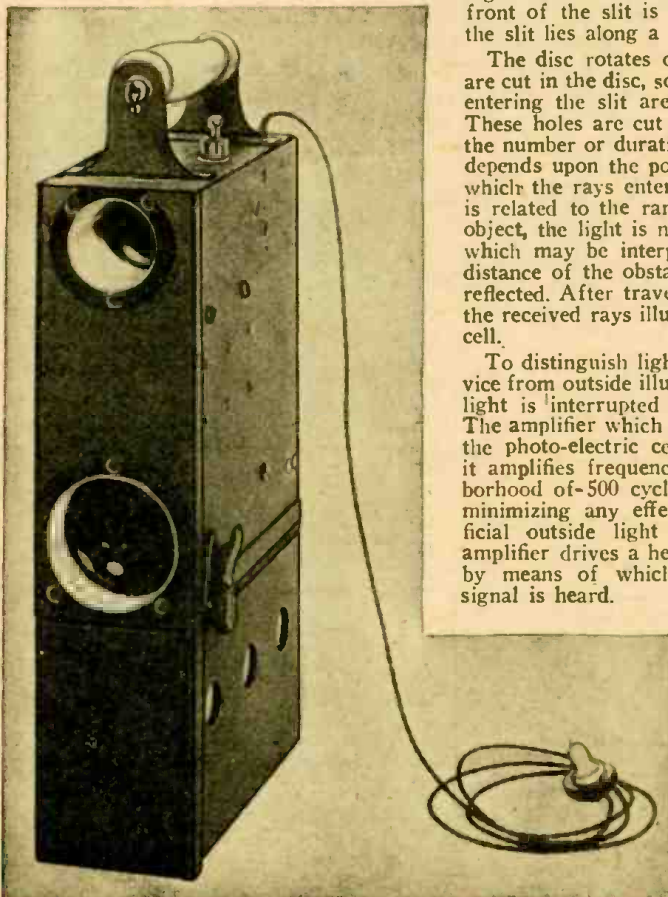

The electronic sensory aid looks like a small handie-talkie. Light interrupted 500 times per second is projected from one lens and picked up by the other.

Radio-Electronics

Items Interesting

the Army Air Forces to forecast weather conditions and thus aid pilots and navigators to choose the most favorable weather conditions for flight. It should also be noted that this data is also utilized by Army Ground Forces in determining ballistic corrections required by the artillery in aiming large guns.

BLIND veterans and others will be aided by an electronic device which gives its user all the benefits of radar on a short-range scale, the War Department announced last month.

The device, called a "sensory aid," employs a light beam instead of radio waves. It is projected from the front of a nine-pound case, carried like a lunchbox.

Two optical systems, one a light transmitter, the other a light receiver, are arranged one above the other, a few inches apart, with their axes parallel. Emerging from the transmitter is a narrow beam of light originating in an ordinary flashlight bulb. When the beam strikes an intercepting object, rays are reflected back and are brought to a focus in the receiver. If the intercepting object is at a great distance, the reflected rays come to a focus on the axis of the receiver lens, but as the distance decreases, the point of focus moves along a straight line in a direction approximately perpendicular to the axis. Coinciding with this line is a slit. Immediately in front of the slit is a disc, located so that the slit lies along a radius of the disc.

The disc rotates once per second. Holes are cut in the disc, so that the received rays entering the slit are interrupted or coded. These holes are cut in such a manner that the number or duration of the interruptions depends upon the position along the slit at which the rays enter it. Since this position is related to the range of the intercepting object, the light is now coded in a manner which may be interpreted in terms of the distance of the obstacle from which it was reflected. After traversing the disc and slit, the received rays illuminate a photo-electric cell.

To distinguish light projected by the device from outside illumination, the projected light is interrupted 500 times per second. The amplifier which amplifies the output of the photo-electric cell is designed so that it amplifies frequencies only in the neighborhood of 500 cycles per second, thereby minimizing any effect of natural or artificial outside light on the system. The amplifier drives a hearing-aid type receiver by means of which the coded 500-cycle signal is heard.

"BONDED Electronic Technician" is the sign many radio servicemen will display in the near future, Arthur E. Ackeroyd, distributor sales manager of Raytheon, announced last month. Mr. Ackeroyd's plan includes protection both to honest and reliable radio servicemen and owners of radio receivers.

Radio dealers and servicemen recommended by distributors will be required to fill out an application form, on which they list their qualifications, repair equipment on hand, and qualifications of employees engaged in radio servicing. If satisfactory, Raytheon arranges bond for them through a well-known indemnity company. Repair work is to be guaranteed for 90 days. If parts or labor fail to give complete satisfaction during this period, the serviceman must rectify the condition. If he fails or refuses to do so, the customer may complain to the bonding company, who will if necessary give the work to another service organization.

The serviceman will of course have an opportunity to present his side of the case while it is under investigation. If the customer is wrong, he is so informed by the bonding company, whose decision—as that of an impartial third party—he is likely to respect.

The bonding system is expected to be of benefit to radio sales as well as servicing. By adding to the customer's confidence in his repair man, he will be encouraged to own more and better radios.

CITIZEN radiophones will be available before the latter part of 1946, at a cost of \$50 to \$100, it was predicted in Washington last month.

FCC and Department of Commerce said that only minor statutory difficulties had to be solved before the personal radiophones could be put into use, permitting communication over short line-of-sight distances on frequencies between 460 and 470 megacycles.

At least three manufacturers have announced plans to make sets available. The Federal Communications Commission stated that it would hold hearings soon to establish standards and regulations.

APLICATIONS for eight unattended automatic relay stations were granted by the FCC last month. The application was made by RCA, who will use the stations for research and development of practical automatic unattended radio relay lines of communication. The eight microwave relay stations will be located in New York and Washington, with intermediate points at New Brunswick, N. J., Arney's Mount, N. J., Philadelphia, Wilmington, Harve de Grace and Baltimore.

Determination of the feasibility of unattended relay stations to connect broadcast stations all over the country should be a valuable contribution of study to be conducted on the newly authorized relay stations, which have also been given permission to divert commercial international telegraph and telephone traffic handled by RCA to these facilities for experimental purposes only.

Monthly Review

to the Technician

VISIBLE SPEECH an actual and faithful reproduction of speech itself, is now possible by electronic means. Apparatus demonstrated last month by Bell Telephone Laboratories transformed the complex waves of speech into light and sound, throwing them on a screen, whence observers could see at a glance the character of the sound, whether it be speech, music or noise. A man deaf since birth watched the changing patterns of light and repeated aloud words which

described readily in words. A set of phonograph records is bulky and requires playback apparatus. Visible Speech records can be printed as halftones, together with text to point out their peculiarities.

Study of industrial machine noise has already proved fruitful, using existing instruments to indicate the loudness at various frequencies. The Visible Speech technique will yield this information at a glance, since the loudness is instantaneously apparent at a large number of frequencies. Single concussions, such as knocks, can be seen, and sounds too short to be recorded by present instruments can be resolved into their components.

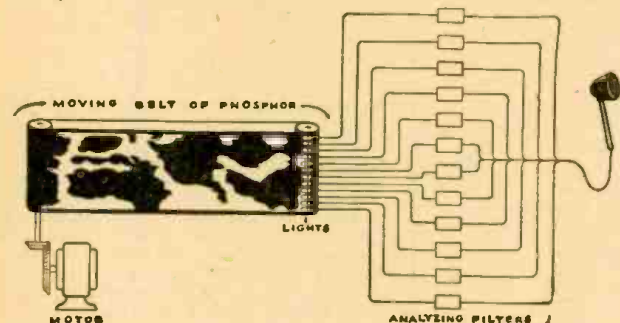

Left—Filter system used for separating the frequency bands. Below—"Radio-Craft" in Visible Speech.

R A D I O C R A F T

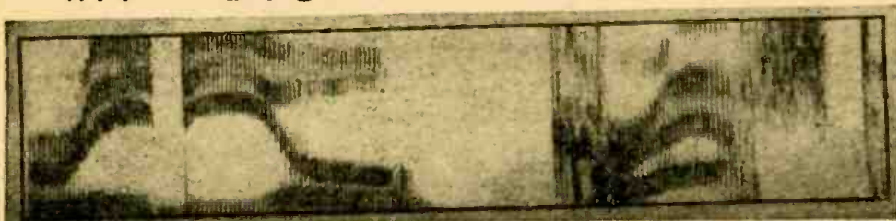

had been spoken by members of the audience. Women, specially trained to read the patterns, took part in a telephone conversation of which no sound reached their ears. The audience listened to both sides of the conversation, and had no doubt that the talkers interpreted correctly from the patterns on the screen what was being said to them.

Using a series of filters which separate high- and low-frequency sound components, the instrument projects the voice elements on a phosphorescent screen. Higher frequencies appear at the top of the screen and lower ones at the bottom. Intensity is expressed by degree of light and shadow, and the time element of speech by position on the moving screen.

Besides being of great value in the study of speech, the instrument has vast practical possibilities in teaching the deaf to speak. The great difficulty has been that the deaf person cannot hear his own speech; therefore his pronunciation may be impossible to understand by anyone who has not learned his individual peculiarities. With the new instrument, he can compare his speech patterns with those of a speaker of standard English and make immediate and extensive corrections and improvements.

Since the differences of dialect are readily perceptible in Visible Speech patterns, the device should be an effective means for linguistic studies. Dialects can be recorded by a phonograph, but while their differences can be heard, they cannot be

ANTI-RADAR measures had some special quirks, it was revealed last month by the Harvard Research Laboratory. The Laboratory, which specialized in radar countermeasures, under the Office of Scientific Research and Development, carried on a friendly war with the Radiation Laboratories of M. I. T., just a mile away, jamming their latest radar developments.

The anti-radar devices were of two general types: aluminum foil, called "Window" and electronic detectors and jammers, working on radio-transmitter principles.

The Allied use of Window became public knowledge during the war, but today's announcement reveals for the first time how and on what a vast scale it was used. It is estimated that the Allied Air Forces dropped more than 20,000,000 pounds of these foil strips in Europe alone. The fields of Europe were so heavily blanketed with foil that in some places the ground seemed covered with snow. The people of Germany used it for Christmas tree decorations. Almost the whole production of United States aluminum foil went into Window; that explains why there were no foil wrappings on cigarettes and candy bars.

It may seem odd that these thin strips of foil, only a tiny fraction of an inch wide and a few inches long, should have wrecked the German radar system. A scientific trick made it work. Aluminum foil, to begin with, is an excellent radio reflector; hence it returns a relatively strong radar echo in proportion to its size. The scientists found that they could multiply the effect by cutting the strips to one-half the radar's wave length. For example, to jam a 50-centimeter wave length radar, 25-centimeter (10-inch) lengths of foil were used.

To jam more than one wave length simultaneously, strips of varying lengths were required. These "tuned" strips, by resonance, sent back a very strong echo. A 6-ounce bundle of 6,000 strips, dropped from a plane and scattering in the air, looked to a radar like three heavy bombers. The German gunners, fooled by the false echoes, fired at the Window instead of the planes. By dropping clouds of foil, Allied planes in effect were able to conceal themselves in an electronic "smoke screen."

A radar can be jammed only by radio waves of the same wave length, or frequency. Therefore, the basic instrument in radar countermeasures was an electronic detective called the "search receiver," which could be tuned to intercept a radar signal and determine its frequency. Equipped with a directional antenna, this receiver could pick up enemy radar signals as easily as broadcast stations on a home radio receiver. The next step was to use a direction finder to locate the enemy radar, so that jamming signals could be beamed on him. Complete search and locating equipment was installed in airplanes for use in some remote spots, such as the Aleutians. Once identified and located, jamming apparatus was put into action.

The Allies' electronic jammers operated on the simple principle of radio interference, which is familiar to any home radio listener who has ever received broadcasts

(Continued on page 290)

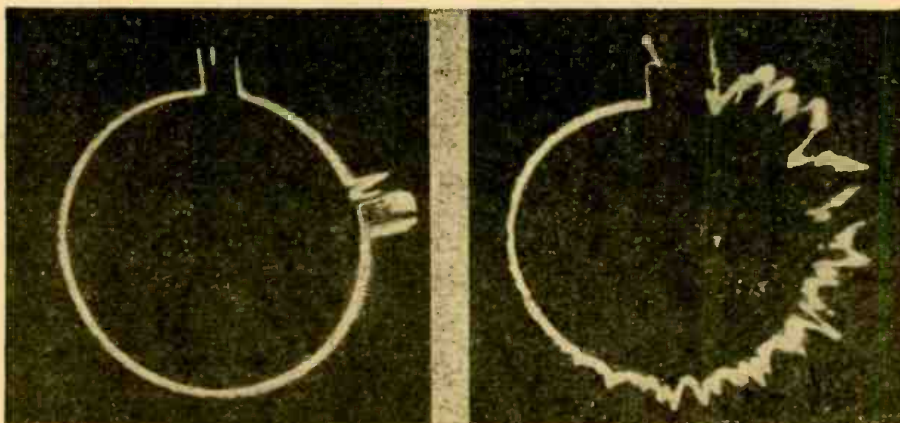

Left—German radar screen shows pip from plane. Right—Pattern broken up by "window."

LORAN— Radio Navigation Aid

By E. F. BRISSIE

TOWARD the end of World War II electronics had come to play the leading role in air and surface navigation. Radar, already established for its service in keeping paths clear for ships and airplanes, had as its running mate a system of radio navigation that enabled a vessel hundreds of miles at sea, with visibility zero because of fog and storm, to fix its position accurately within a few minutes. Both Army and Navy used this system, and it was kept a closely-guarded secret among the United Nations. Its name is *Loran*.

Loran (derived from LOnG RAnge Navigation) is sometimes referred to as the radio navigator. While previous radio navigational aids have depended upon direction finding, operated by determining the *direction* from which the radio waves reach a receiver aboard ship or airplane, loran operates on a principle of measuring in micro-seconds the *time* necessary for radio pulses to reach a vessel from shore-based transmitter stations. Radio direction finding, already in use for more than a quarter of a century, is not highly dependable, due to unpredictable vagaries of wave propagation. Loran avoids those vagaries; and if noise is low enough to permit the navigator to get a reading, it will usually be a dependable one.

For the navigator, loran can obtain accurate *fixes* at ranges of 600 to 800 miles in daytime, and from 1,200 to 1,400 miles at night. A tremendous factor in favor of loran as an instrument of wartime navigation is the fact that no transmission from aircraft or ship is required; and radio silence in enemy territory is a basic "must"

among aviators and sailors. Loran fixes may be obtained by skilled operators within as little as two minutes time, and no fix is dependent upon use of a compass, chronometer or any other form of equipment.

Basically, loran operates on the following principles: 1—radio signals consisting of short pulses are broadcast from a pair of shore-based transmitting stations; 2—these signals are received aboard ship or airplane on a radio receiver specially designed for handling the signals through the various steps leading up to loran readings; 3—the difference in time of arrival of the signals from the two radio transmitting stations is measured on a special indicator; 4—this measured time difference is utilized to determine directly from special tables and charts a line-of-position on the earth's surface; this line is known as a "loran line-of-position."

Two or more of these lines-of-position, determined from two or more pairs of transmitting stations, are crossed to obtain a loran fix. The navigator may cross one such loran line with a celestial line-of-position or with a visual bearing line to obtain a fix.

Loran differs from its kin, radar and radio direction finding, in that no transmission takes place from the ship or airplane, as in the case of radar; and it measures radio waves' time of arrival rather than indicating the direction of origin, as in the case of RDF. In contrast to bulky, expensive radar equipment, loran sets are now made weighing as little as 35 pounds. Commercial users will probably be able to purchase the set for less than \$500, according to technicians' estimates.

Loran operates as follows: A loran transmitter ashore broadcasts short power pulses of radio energy into space, in all directions. Equipment at the transmitter includes a transmitting timer to regulate the pulse recurrence rate, and a monitor, a device which permits matching the recurrence rate of one station to the other member of the pair. (The timer and monitor are generally referred to as "timer." This timer triggers the transmitter at the correct instant, in addition to providing means of comparing the pulse emitted, with the pulse from the

Lieutenant Eugene F. Brissie occupied a rather enviable position during the war in that most of his four years of sea duty was put in aboard capital warships, two aircraft carriers and a battleship. Spending most of his service in fire control and navigation, he had an opportunity to see in actuality the incredible assistance offered by radio and



electronics to a fleet fighting the greatest duels in naval history.

While serving aboard an aircraft carrier he began to use loran in navigation.

A native of South Carolina and 28 years old, Lieutenant Brissie worked as newspaper reporter and instructor in journalism and English at Wake Forest College, North Carolina, before joining the Navy in mid-1941. Following several months with the Navy Office of Public Information in New York, he was released to inactive duty in November. He returns to civilian life in the news bureau of Eastern Air Lines, Inc., in New York.

other station of the pair, so the correct absolute lag between the two stations may be maintained.) The pulses sent out by the stations last about 40 microseconds, and they recur at regular intervals, the interval being about 1000 times greater than the time used in pulsing. The short pulses of radio energy provide precise index marks for use in time measurements, and since the transmitters ashore are transmitting such a small percentage of the time, tremendous peak powers can be secured from a relatively small transmitter during the interval when the pulse is actually being sent out. The pulses travel at a constant speed, 162,000 nautical (186,000 statute) miles per second, therefore the distance to the loran receiver can be measured in radio-wave travel time. A cathode-ray tube in the indicator at the receiver measures the distances in micro-seconds, and the time difference establishes a single line-of-position by reference to special tables and charts.

The stations are usually arranged so that two stations of a pair are separated by 200

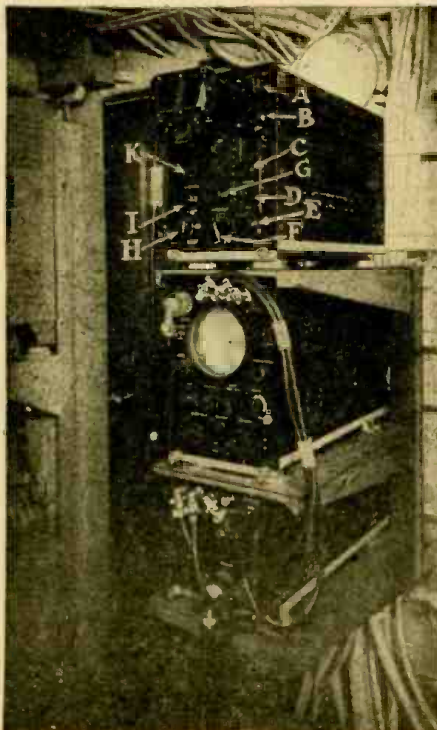

Photo, left—Two models of loran equipment. Top one is modern and contains all latest improvements. A is framing control; B—drift; C—tuning; D—pulse recurrence rate; E—fine delay; F—sweep; G—coarse delay; H—amplitude balance; I—receiver gain; K—RF channel. Fig. 1, right—How loran systems work.

Photos courtesy New York Navy Yard

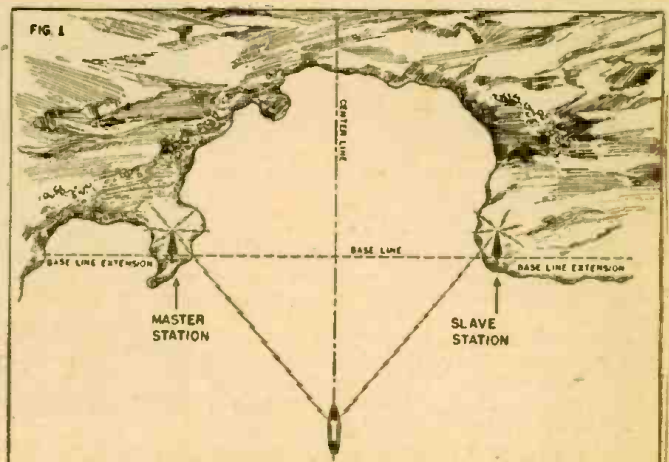

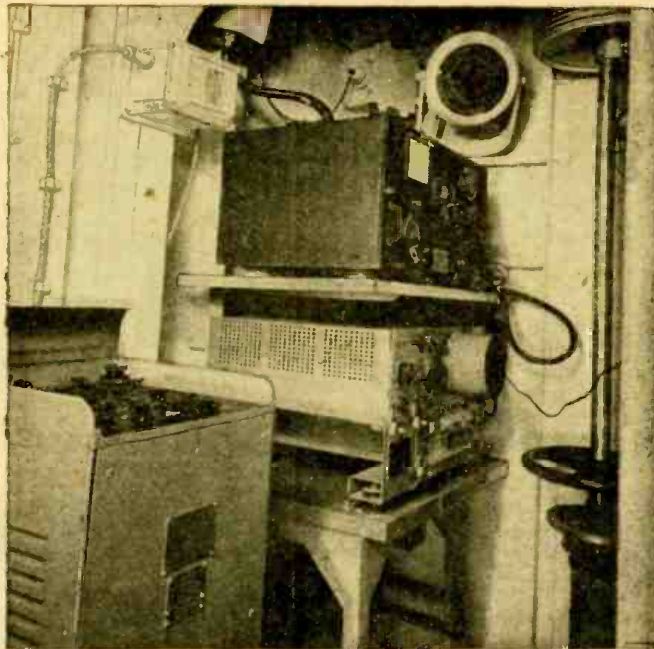
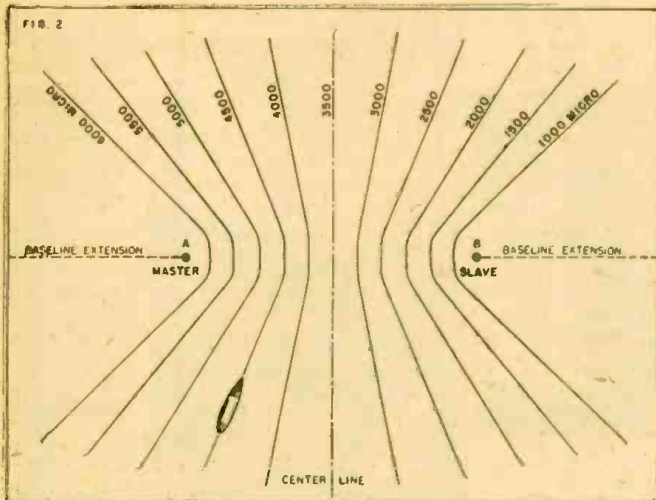

Photo, right—Three stages in development of radio navigation. Upper right is the old direction finder, with its compass and rotatable loop antenna. Below is an early loran, type DS-3, and left, the latest type DBE, which reads the time differences automatically. Fig. 2—Lines of constant time differences between the master and slave stations.

to 400 nautical miles, but under unfavorable geographical situations the separation may be as little as 100 miles or as much as 600 miles. The line between the stations is known as the *baseline*, and the line running perpendicular to the baseline is known as the *centerline*. (See Fig. 1.) To understand the purpose of staggering transmissions, first consider a pair of loran stations transmitting simultaneously: station A sends out a pulse and at the same time station B transmits. If the receiving vessel happens to be nearer A than B, A's signal will be received first; the time of B's arrival will be proportionate to the difference in distances between the receiving vessel and each of the two stations. If the signals were received at the same time, the navigator would know that he was along the centerline of the stations. However, if the ship were located near the centerline and not precisely on it, the time of arrival of the two pulses would be so nearly the same that it would be virtually impossible to make an accurate time-difference measurement. Furthermore, if the two stations were transmitting simultaneously, there would be no way of identifying the signal from each station in the pair, in order to remove the ambiguity of two lines-of-position with the same time difference.

Station pairs are labeled "master" and "slave." Their transmitting patterns typify their titles. The master station transmits first, and, after reception of this pulse, the slave station waits a time equal to one-half of the pulse recurrence interval plus an additional small time known as the *coding delay*, before transmitting its pulse. At all times the interval from master pulse to the next slave pulse is greater than the interval from a slave station pulse to the next master station pulse. This indicates which signal comes from which station, though the two signals look alike. The time difference is always measured from the master to the slave station pulse, and the time delay between transmissions from master and slave station is automatically removed. The result provides a family of loran lines-of-position for each pair of stations (see Fig. 2.) Using the staggered pulsing, the minimum time difference reading on the cathode-ray indicator occurs along the baseline extension beyond the slave station, and the maximum readings—which increase as one moves away from the slave toward the master station—are found along the baseline extension beyond

the master station. Now there is a single line, as shown by the figure, for each time difference. The lines of constant difference,

FIG. 3

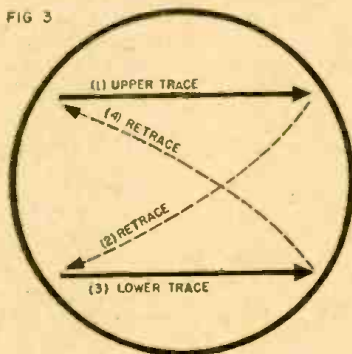

FIG. 4-A

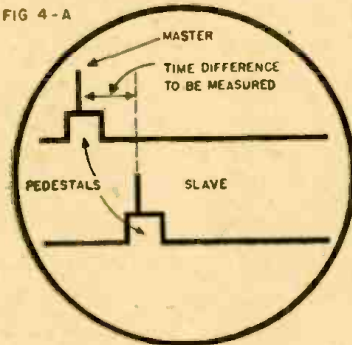
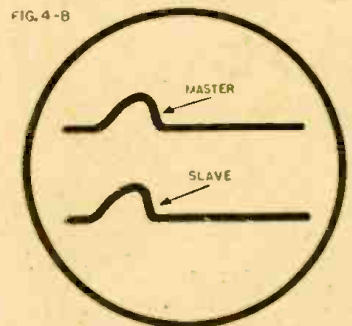

FIG. 4-B



which would appear as a series of hyperbolas, are pre-computed for the navigator, who doesn't have to worry about curvature and eccentricity of the earth as he plots in his loran position on the charts. The coding delay is taken into consideration in the

make-up of the tables used for loran problems, and so can be disregarded.

The loran receiver is basically similar to ordinary receivers. The receiver, cathode-ray indicator and a timing device, which is employed in synchronizing the indicator with the transmitted pulse, make up the whole loran observational equipment. The indicator, which performs the function of an extremely rapid and accurate stopwatch, measures in microseconds the difference in time of arrival of the pulse signals from the two stations of a pair. This instrument combines a cathode ray oscilloscope, a crystal clock, and auxiliary controlling circuits. Pulses from the two stations are traced upon the screen of the scope, along a horizontal line of light—the *trace*. The elapsed time between pulses is measured by the distance along the trace from one pulse to the other, just as the elapsed time between two events is measured by the distance around the dial of the stopwatch. The trace, which appears as a greenish, flickering line of light, is made by a rapidly moving spot of light, traced by the electron stream within the indicator, moving rapidly across the viewing screen.

During the recurrence interval (about 40,000 microseconds), the spot of light traces out the time pattern in the following sequence: 1—the spot sweeps steadily from left to right across the upper part of the screen in a little less than one-half the pulse recurrence interval (about 19,930 microseconds), forming the upper trace (see Fig. 3); 2—the spot then snaps downward and to the left, forming a retrace in a matter of a few microseconds (about 70); 3—the spot sweeps steadily from left to right across the lower part of the screen in the second half of the pulse recurrence interval, forming the lower trace; 4—the spot then snaps upward and to the left, in a very brief retrace (about 70 microseconds required). The sequence of spot movement is repeated 25 times per second, and because of the persistence of vision, the rapid spot movement appears to form continuous, slightly flickering lines of light.

This entire motion is controlled by the crystal clock, which has a vibrating quartz crystal instead of a balance wheel and a series of radio tubes and circuits instead of gear wheels. This clock gives the light spot a slight vertical jerk every ten microseconds, stronger jerks every 50 and 500 microseconds. This action superimposes time

(Continued on page 277)



1—A bus driver using new two-way radiophone.
2—Dispatcher's office gets call from a bus.
3—Side view of the bus transmitter-receiver.



RADIO ON BUS LINES

By S. R. WINTERS

A WOODLAND fire, fanned by high winds and intensified as the consuming flames gather momentum, envelops the appointed route of a bus company. The flip of a key on a frequency-modulated radio control unit enables the bus company's dispatcher to summon all available inspectors to proceed to the fire's location to reroute vehicles, thus averting temporary paralysis of traffic. Formerly a chance telephone call to headquarters was the sole means of avoiding such traffic tie-ups.

If a bus running on its regular schedule has an abrupt breakdown, an inspector communicates by static-free radio (FM) with the company's dispatcher's office and a replacement bus is sent immediately. If the disruption of traffic is due to only a minor mishap a radio-equipped truck or

service car may be dispatched to the location of the tie-up; the necessary repair equipment being taken from the headquarters shop to the disabled coach on the highway. Thus there is a speed-up of repair work and a consequent quick resumption of transportation service.

A shopper in Washington, D. C. (still a city of maddening crowds and that tenseness which is the aftermath of war), hurrying to catch a bus running into Maryland or Virginia suffers a heart attack, requiring immediate medical attention. By means of FM radio a doctor can be summoned or a first-aid station functioning along the highway can be informed of the cardiac trouble.

"There was a wreck on the highway, blood and whiskey running together, and I heard nobody pray," is the gruesome and

yet faith-provoking thought expressed in a mountain ditty. Too, Henry Ford once said you cannot successfully mix liquor and gasoline. Without sermonizing, a radio-equipped bus is enabled to broadcast the news as it approaches the location of a tangled mass of human and mechanical wreckage, thus summoning help.

While banditry on national bus systems does not partake of the Jesse James style of train hold-up, occasionally a thief may seize the cash-box on a bus, if he can dislodge it. There is the possibility of a get-away with stolen money. Radio at the command of the bus operator would aid in the speedy apprehension of this or other types of criminals. Should it be suspected, for example, that a criminal is fleeing on a bus, the driver can be notified, leading possibly to capture of the lawbreaker.

The foregoing examples of the application
(Continued on page 283)

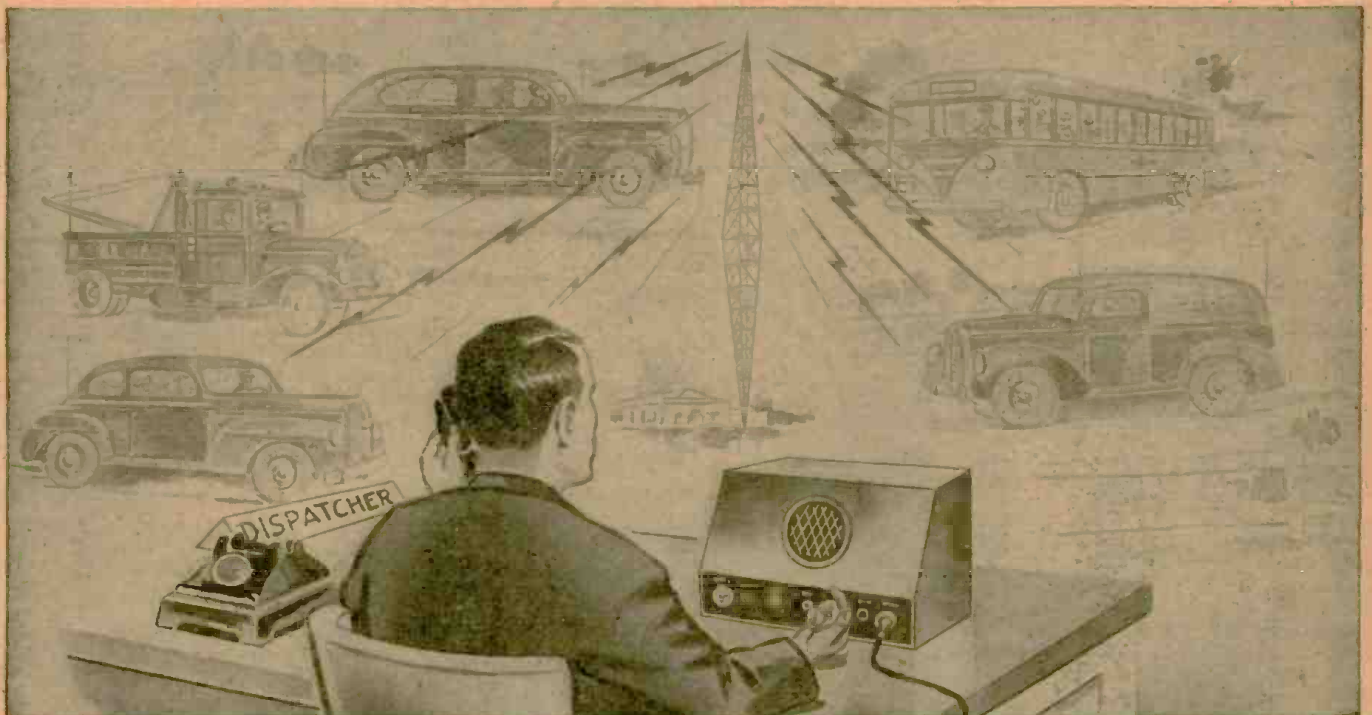

Artist of the Washington, Maryland and Virginia Coach Lines envisions complete control of future traffic by a two-way radio system.

144-MC RADIO

A V.H.F. receiver is described in this article. Details of a 148-Mc. transmitter will be printed in an early issue.

By I. QUEEN*

ON August 21, 1945, the FCC issued its Order No. 127, which reopened the so-called 2½-meter amateur radio band, covering from 112 to 115.5 Mc. All amateur radio licenses which were valid at any time during the period from December 7, 1941, to September 15, 1942, and which were not subsequently revoked were declared operative in this band only. It was further stated that such operation could continue until November 15 at 3 A. M. E.S.T. It was anticipated that further policy regarding amateur radio would be announced before that date.

Thousands of amateurs have been quick to respond to this opportunity to get back on the air. The band is now experiencing mild to serious QRM during the popular hours of the evening, at least in metropolitan centers. Many who are working the "ham" V.H.F. for the first time have obtained valuable experience either as a result of recent war work or military communications.

In general, the V.H.F. of about 100 Mc and higher are limited to line-of-sight distance. This means that greater distances are covered by higher antenna systems. Fig. 1 illustrates approximate line-of-sight distance vs. antenna height. To find the distance which can be covered between two stations, add together the distances which correspond to each antenna height.

Fig. 1 does not explain why the band "opens up" at certain times to make it possible for two-way communication to be carried on between Washington and Baltimore amateurs or between Staten Island and Philadelphia, for example. Then again, distances of several miles are sometimes covered by operators working mobile from cars with low antennas. "Hams" who have had previous experience with these frequencies look for better than prevailing conditions with the coming of colder weather.

The V.H.F. permit very compact and simple sets and components. Mobile stations (such as in cars or boats), can be conveniently outfitted by amateurs. Such sets can be operated from storage battery and vibrator supplies.

New amateur stations are not being licensed at present, but operator licenses can be obtained. However, station licenses will doubtless be available in the very near future. The V.H.F. offers certain advantages to the newcomer. Phone operation is permitted without a class "A" ticket, for example. A self-excited stage is found to be ample. Finally, the small components permit a better appreciation of the principles involved. Nodes and loops are only a few feet apart, so that changes in antenna coupling or an impedance change give results which may be checked visually. It is a beautiful opportunity to prove for oneself what the text books say about transmission lines and directional antenna systems.

Many ordinary tubes cannot be used at

very high frequencies because of capacitance and leakage paths. Among efficient types are the 7A4, 6C4, 9002, 1201 and 955. The latter two are somewhat similar and are effective even at 700 Mc. Since the chances are that the present band will be moved upwards and still higher frequencies made available, these tubes will also prove useful in the future. Because of its compactness and effectiveness, the 955 is used in many ham shacks.

There are three general types of receiving equipment for frequencies above 100 Mc: the superheterodyne, the converter and the super-regenerative circuit. The first is a complicated receiver for very high frequency use. For minimum image interference a very high I.F. is required. A typical receiver is the Hallicrafters S27 which covers from below 28 to above 144 Mc. (in three bands). This is a very sensitive and selective set which can be used for either phone or CW and AM or FM.

The converter can be used where a good communications receiver is already available. Special high-frequency tubes should be used, but the general principles are the same as in low-frequency converter circuits.

THE "SOUP-REGENERATOR"

Most amateur receivers on the V.H.F. are "rush boxes." These super-regenerative

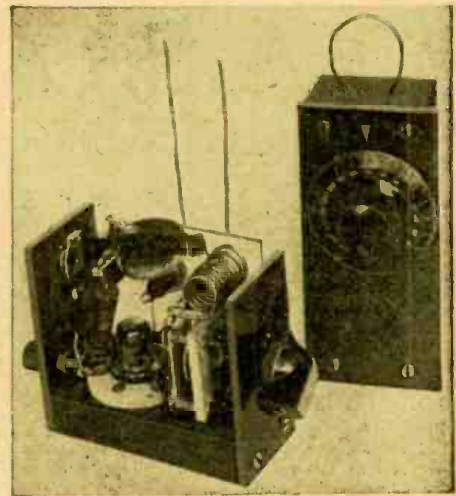

Front view of the 955 receiver and wavemeter. Vertical leads form part of line to dipole.

receivers are named for the characteristic rushing or hissing sound which is present until a station is tuned in. The stronger the signal, the greater the reduction of hiss. Super-regeneration provides the most sensitive yet simple circuit yet devised. Its disadvantages are: noise, broad tuning, no response to unmodulated signals and the possibility of re-radiation. Since many signals tend to be frequency modulated at these frequencies, the disadvantages are not too serious. A low plate voltage reduces re-radiation.

A simple circuit using the 955 acorn tube in a super-regenerative stage is shown in Fig. 2. This receiver is used here at WIHCO (operating portable at Brooklyn) in a not too favorable location. It has been used as shown, but a two-stage amplifier can be added for speaker response. It is

(Continued on page 284)

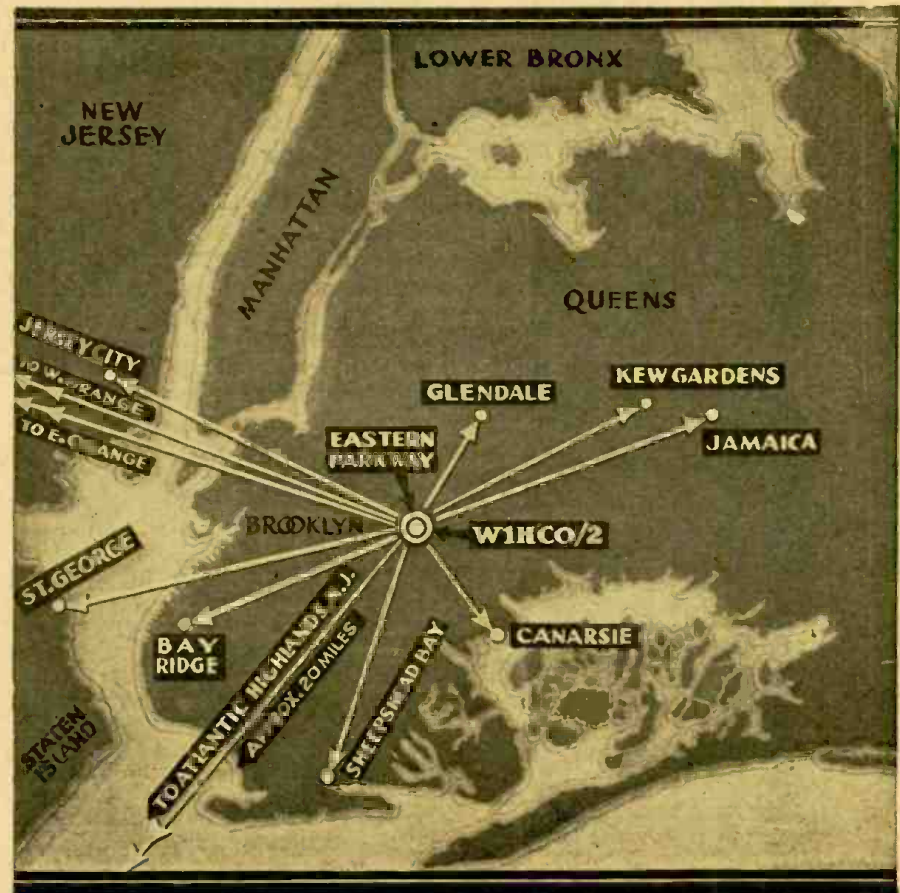

*WIHCO/2, Brooklyn, N. Y.

QSO's by WIHCO/2 in first week of operation (on 112-Mc band). Note absence of contacts to north where a high hill intervened.

A.S.C. Radio

This Receiver Has Automatic Selectivity Control

By E. AISBERG*

THE greater the selectivity of a radio receiver, the poorer the quality of its acoustic or musical reproduction. For such a receiver, since it passes only a narrow band of the frequencies which make up the modulation, thereby cuts off, or at least attenuates, the upper range of musical frequencies.

It is advisable, when a strong signal is received at the antenna, to make use of a low selectivity receiver—one which passes a wide band.

But, when the signal is weak, the receiver must be highly selective. If not, quality of reproduction risks being marred by whistles due to adjacent carrier interference as well as static and hiss. It is thus preferable to sacrifice reproduction of high-pitched musical notes to preserve speech intelligibility and musical clarity.

Making due allowance for these considerations, it has been possible to make *variable selectivity* receivers which adapt themselves in the best possible manner to changing receiving conditions. In the course of the last ten years many have been produced. Thus, when listening to a powerful or nearby transmitter, selectivity will be reduced and the musical qualities of the set exploited to the full, while in the case of a weak signal, selectivity will be increased and the result obtained will remain satisfactory.

Nevertheless, variable-selectivity sets have a certain number of drawbacks:

1—With many of these circuits, variable selectivity causes a certain amount of detuning.

2—Listeners are unable correctly to make use of selectivity adjustment. This drawback, which might be called "psychological," while obviously not inherent in the circuit, is none the less a serious one.

3—While the higher notes, when the set is adjusted for high selectivity, are being attenuated by the high and intermediate frequency sections of the circuit, it must be remembered that they continue being amplified by the audio-frequency stages in the same ratio as the other notes of the musical spectrum. As a consequence of this,

the noises produced in the receiver (hum, etc.), static crashes and interference whistles, stand out all the louder since the higher pitched notes of the musical reproduction cease to be strong enough to "mask out" these undesirable sounds.

OVER-ALL SELECTIVITY

It is possible to eliminate this last defect by combining selectivity adjustment with tone control so that the audio-frequency

*Editor, *Toute la Radio*, Paris.

amplifier high-note attenuation increases with higher selectivity.

This leads to the concept of *over-all selectivity*, which takes into consideration not only the band passed by the sections which precede the second detector, but also the band passed in the audio-frequency stage. It is logical to vary simultaneously the respective selectivities of *all* the circuits (both radio and audio-frequency), to ensure that the cut-off limits imposed on the modulated carrier frequencies be the same both before and after the second detector. It is quite unreasonable either to follow a wide band-pass radio-frequency amplifier with audio-frequency circuits which markedly attenuate the higher notes, or to make use of a high-fidelity audio-frequency amplifier after highly selective radio frequency circuits.

The double path receiver designed by our friend R. Aschen provides a solution to the problem which has just been outlined. A schematic illustration of its essential principles is given in Fig. 1.

At a given point, in the succession of high or intermediate-frequency circuits, the voltages are routed over two separate paths:

1—A *high overall selectivity path* consisting of high or intermediate frequency circuits having narrow band-pass characteristics (5 to 6 Kc.), a detector tube which attenuates the higher musical notes, an audio-frequency amplifier and a loud-speaker which both favor the low and middle registers, with a frequency response curve falling steeply after 3 Kc.

2—A *low overall selectivity path* com-

Mr. E. Aisberg is the director of the principal French radio technical magazine *Toute la Radio*. He is the author of the most popular French radio books. His first work written in 1926, *I Understand Radios*, has been trans-



lated and published in nineteen languages.

His first popular radio book, *Radio? It is So Simple!*, has been since 1936, the best seller in French technical literature. In 1926 Mr. Aisberg published the first television magazine in Europe and founded the French Television Society.

Owner of many original patents, principally in the domain of frequency modulation, Aisberg, during the German occupation, was active in the French Underground in the department of Haute Savoie. He constructed many clandestine transmitters and receivers for the French cause.

Mr. Aisberg is President of the technical section of *Radio Journalists of France* and the founder and director of the French Radio Publishing Corporation.

tiometers determines at one and the same time the selectivity of the whole set. Thus, with P_2 at zero and P_1 at a maximum, the circuit is highly selective and well adapted for the reception of weak signals. Conversely, with P_2 at maximum and P_1 in an intermediate position, the selectivity of the receiver is low and it will reproduce strong signals with the utmost fidelity.

It will readily be appreciated that since the two potentiometers can be adjusted to any combination of an infinity of possible positions, one can adjust at will the three essential characteristics of the receiver, namely: 1—Selectivity, 2—Tone, 3—Volume.

Fig. 2 shows, by way of example, the schematic of a double path superheterodyne built according to the principles outlined above.

Separation of the signal over the two paths is effected after the converter tube by means of two intermediate-frequency transformers, the upper set, TR, and TR',

having narrow band-pass characteristics (high selectivity), the lower path having, on the contrary, wide band-pass transformers TR₂ and TR'₂ (low selectivity).

The detector by-pass condenser of the upper path has a capacity of 250 mmf., thus greatly attenuating the higher notes. A .003 mf. condenser, which by-passes the anode of the output tube, has the same effect. In the lower path, on the other hand, the low notes are most attenuated because both audio-frequency coupling condensers

The name of Aisberg will be remembered by pre-war readers of RADIO-CRAFT. The present article from his pen is his first postwar effort.

Born in Russia, Engineer Aisberg was persecuted and hounded by the Nazis, and his publication TOUTE LA RADIO was of course not in evidence during the years of occupation.

Even today conditions in France are deplorable. To Americans who have not been abroad it is difficult to understand that when Mr. Aisberg sent in his letter he asked that the honorarium should not be in form of a check, but requested that he be paid with the following articles:

Chocolate, cocoa, toilet soap, shaving cream, corned pork, coffee, needles and thread, canned ham and high-speed razor blades.

It should be noted that Mr. Aisberg is living not in an obscure little country, but right in De Gaulle's Paris, France.

So, next time you are being asked to contribute to a sadly ravished France, you will realize that the need is indeed great.

prising wide band-pass oscillatory and intermediate-frequency circuits (15 to 20 Kc.), a detector, amplifier and loud-speaker favoring the reproduction of high notes.

Furthermore, a suitable gain-adjusting device is provided for each path. In Fig. 2, these are potentiometers P_1 and P_2 , at the input end of the audio-frequency amplifiers.

The first of these potentiometers controls the volume of low and middle register notes while the second acts on the higher ones. However, the adjustment of these poten-

have the exceptionally low value of .001 mf. The whole upper path, including the loud-speaker, is therefore characterized by a high degree of over-all selectivity and a consequent marked attenuation of high notes. The selectivity of the lower path, on the contrary, is low, and favors these high notes while tending to attenuate the lower register.

Were the respective adjustments of potentiometers P_1 and P_2 independent, they

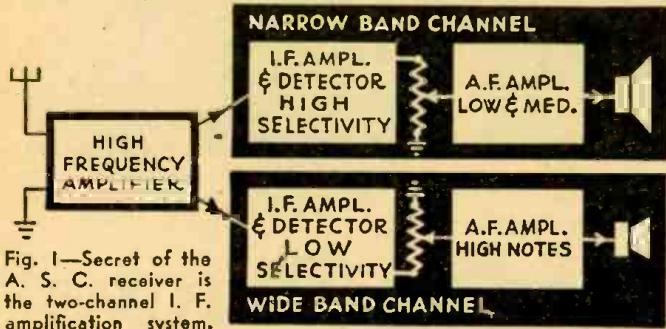

Fig. 1—Secret of the A. S. C. receiver is the two-channel I. F. amplification system.

would have the function indicated in Fig. 1. It is possible, however, as indicated in the illustration by the dotted lines, to "gang" these adjustments. Since the movement of both sliding contacts is controlled by a single knob, rotation of this knob will cause a variation in volume without any appreciable tone modification. This, in other words, is a standard volume control device.

In order to adjust over-all selectivity and reproduction tone, it is necessary to provide two additional potentiometers P_1 and P_2 . The former controls the notes of the lower register while the latter adjusts the higher notes. By ganging them "in reverse", as indicated in the figure, so the attenuation of one increases while the other is reduced, it is possible to enhance the musical contrast thus obtained.

We now have a set which the listener can adjust without difficulty. The knob used to control P_1 and P_2 is a standard volume control. As far as the listener is concerned, the knob which operates P_1 and P_2 is nothing but a tone control—little does he realize, as he twirls it, that he causes a progressive variation in the selectivity of the set.

AUTOMATIC CONTROL

We can do better. To enhance the selectivity and tone contrast between the two paths, while making these two character-

istics automatically dependent on signal level or strength, it suffices to make use of A.V.C. voltages. The only condition required to this end is that the A.V.C. voltage in the upper path be greater than that available in the lower path.

Thus, with strong signals, the attenuation of low notes is greater than that of high notes, which makes it possible to obtain a satisfactory balance as between the various musical registers. On the other hand, with weak signals, the lower notes are less attenuated than the upper ones and their volume enables them to act as a "mask" for the noise present in the upper register.

An automatic selectivity control system may be obtained by applying to the lower path only a fraction of the total A.V.C. voltage, while the tubes controlled by the A.V.C. voltage in the upper path receive the whole of this voltage. Furthermore, the A.V.C. effect can be increased by applying the regulation voltage to the audio-frequency pre-amplifier tube as well. In some extreme cases, it is possible completely to cut off A.V.C. regulation voltages

by the detector of the upper channel is applied to the lower one. This is indicated by the dashed lines in Fig. 2. It will be noted that tapping in on the resistor from P_1 to ground makes it possible to make use of only a fraction of the A.V.C. voltage available in the upper path.

Let us now consider the operation of such a set. Since the AVC is attenuated in the lower path, the A.V.C. voltages which it produces through its diode vary in turn more markedly with signal fluctuations than do the A.V.C. voltages obtained at the output of the upper diode, since the latter is in a circuit where sharp A.V.C. action tends to establish relative stability.

This type of crossed A.V.C. is in many ways comparable to feedback. Interaction of the two paths causes mutual intensification of the desired effects. Upper-channel A.V.C. will in effect be amplified while that in the lower channel undergoes a variable-rate attenuation. Thus, with weak signals, there is very little attenuation of the low notes while this attenuation is considerable for strong signals. On the other hand, the high notes, in the case of strong signals, are but little attenuated, their attenuation becoming moderate with weak signals.

ALTERNATIVE PRINCIPLE

Instead of establishing a selectivity difference between the two paths by means of highly selective coupling circuits in the

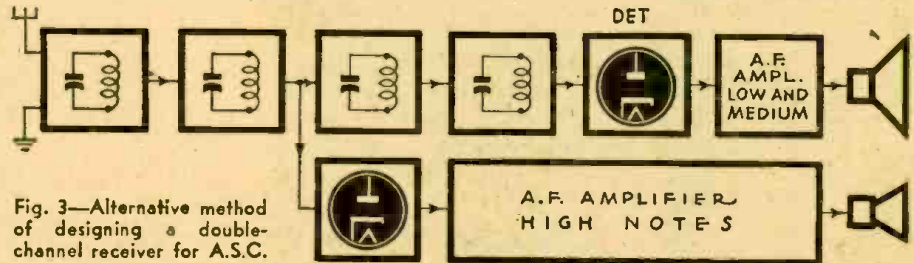

Fig. 3—Alternative method of designing a double-channel receiver for A.S.C.

in the low-selectivity lower path.

Automatic selectivity and tone control represents a very interesting improvement in radio operation. However, this device itself can be improved upon. This will be demonstrated in a discussion of regenerative A.V.C.

Further to enhance the effects described, the A.V.C. voltage from the detector stage of the or lower channel may be applied to the upper path. At the same time, a fraction of the control voltage produced

one and low-selectivity circuits in the other, it is possible to vary the number of oscillatory circuits in the two paths.

Fig. 3 shows, in highly simplified form, how a receiver can be made embodying this new principle. The upper path is made up of the usual highly selective elements, with considerable attenuation of the high notes in the A.F. amplifier stage. In the lower path, signals are applied to the second detector after going through a smaller number of tuned circuits, which markedly reduces its selectivity as compared to that of the upper network. Moreover, its A.F. amplifier and its loud-speaker both favor high-note reproduction.

It must be noted, incidentally, that the voltages applied to the lower-path detector, since they have been passed by a smaller number of stages, are of lesser amplitude than these detected in the upper channel. To re-establish a proper balance, it is necessary to use an audio amplifier having a larger gain than that of the upper path.

SIMPLIFIED DEVICE

Theoretically, a difference of one single tuned circuit between the two paths is sufficient to cause a difference in their respective selectivities. In the schematic shown in Fig. 4, invented by Mr. Louis Gaudillat, the more selective of the two paths uses diode detector D_1 , to which voltages are supplied by the secondary of intermediate-frequency transformer TR, while in the path of lesser selectivity, voltages are supplied to detector D_2 by the primary of this same transformer.

The detected voltages are applied, respectively, to pre-amplifiers AF₁ and AF₂.

(Continued on page 263)

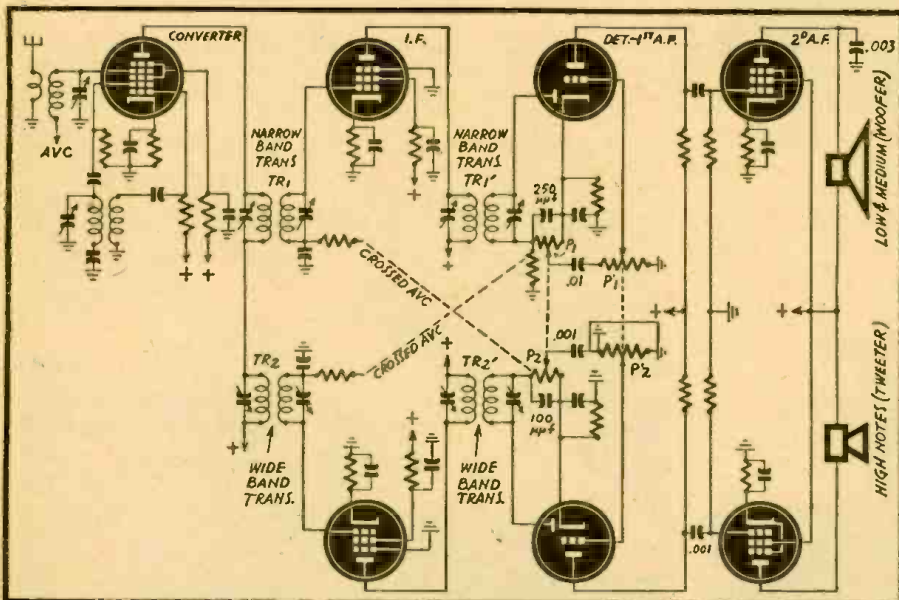
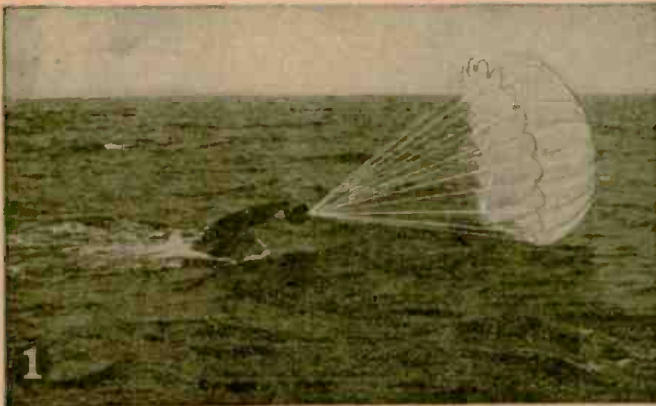
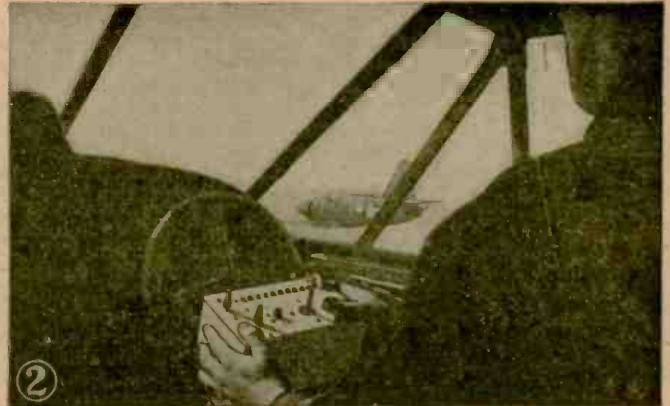

Fig. 2—Schematic of the double-channel receiver equipped for automatic selectivity control.



1—When drone is to be recovered, operator presses remote-control button, releasing the parachute and letting plane descend on water.



2—Controlling target plane with remote stick-control box. Drone responds to radio-linked stick and maneuvers in standard fashion.

COVER FEATURE:— Radio Target Planes

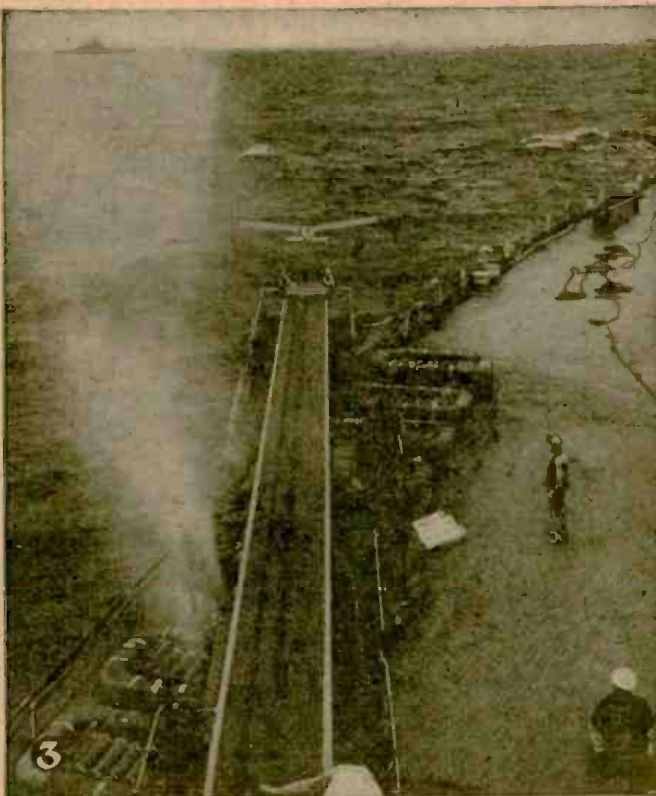

RADIO control of target planes was one of the less spectacular developments of the war just finished. It was no less important because of its lack of glamor. The problem of training anti-aircraft gunnery crews has always been complicated by the difficulty of supplying suitable targets. A towed glider has obvious disadvantages, both in speed, maneuverability, and the ever-present risk to the towing craft.

The target airplane shown on our cover is the result of eight years of intensive work by the Control Equipment Branch of the Army's Equipment Laboratory Staff. Able to fly at speeds up to 200 miles per hour and at altitudes up to 3,000 feet, the targets can be controlled from a simple remote box either on the ground or in another plane.

The Navy is using the radio airplane target in its training program for automatic weapons target practice aboard combatant ships. Navy officers and enlisted personnel have been trained in the operation of the pilotless airplane.

The radio airplane target has recently found another use, that of a training aid for students of radar in tracking flying objects in the air for gunnery practice.

The OQ-3 airplane target is a high-wing monoplane, 9 feet long, with a wing span of 12 feet 3 inches. It weighs 100 pounds and is capable of flying 103 miles an hour. It is constructed of welded steel tubing covered with airplane cloth. The power plant is an 8-horsepower, 2-cylinder, 2-cycle gasoline engine. The OQ-14, a later model, has a wing span of 11 feet, 6 inches and is powered with a 22-horsepower engine. This model will fly 140 miles per hour.

The PQ-14, a low-wing monoplane powered with a six-cylinder 155-horsepower Franklin engine and manufactured by the Culver Aircraft Corporation, was adopted for standard use. The plane has a high rate of climb, *(Continued on page 278)*

3—A radio-controlled drone launched from regular ship's catapult. 4—Close-up of target plane tuning up for radio-controlled flight. 5—"Gorgon", a Navy-developed guided missile, is capable of carrying an explosive charge of 1,000 pounds at more than 550 miles per hour.

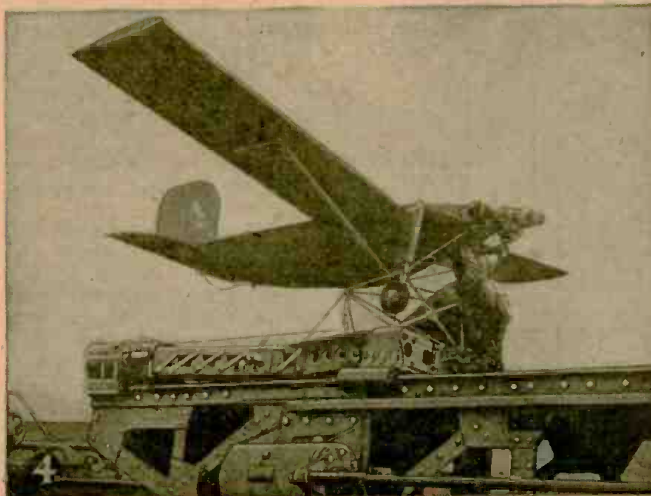

Signal Generator Covers All Bands

By BOB WHITE

THIS signal generator has a continuous range of 65 to 34,000 kilocycles. The signal may be modulated by the A.F. oscillator which has a continuous range of 24 to approximately 20,000 cycles per second.

A small metal cabinet measuring 10 x 6 x 7 inches provides the necessary shielding for the oscillator. The R.F. Hartley oscillator uses a type 6J7 pentode radio tube. Intensity of oscillation is controlled by potentiometer R5 which varies the screen voltage. The switch mounted on R5 serves to turn off the R.F. oscillator when it is not being used.

If operated on a frequency below 2,000 kilocycles, the output switch may be set for the I.F.-A.F. position. It was discovered that a stronger low radio-frequency output was obtained if the coupling was not made directly to the plate of the oscillator. The A.F. output connection can be used for low radio frequencies because the R.F. choke isolates the plate from the output connection. The intensity of the oscillations reaching the output leads is controlled by R10 at low radio frequencies and audio frequencies; but when operating on a frequency greater than 2,000 kilocycles, the output switch is set to the R.F. position and the intensity must be controlled by the voltage potentiometer R5.

The condition of the 6J7 tube can be determined by connecting a 0-150 D.C. voltmeter across resistor R6 and choke T1. The oscillator tube draws a large current while not oscillating and a much smaller current while oscillating; therefore, a large voltage drop reading will indicate that the tube is not operating properly. If the grid cap of the oscillator tube is touched, the reading will increase providing the tube is oscillating. If no meter is available, a rough check can be made by connecting a midget neon lamp to the meter jacks. If

the 6J7 is not oscillating, the lamp will glow. It should be noted that the plate current flow will also decrease if the screen voltage is reduced or the coil is removed.

Resistor R6 serves to place the plate of the oscillator tube at a lower potential than the modulator tube so that more modulation may be secured. Either a plate coupling choke or the primary winding of an audio transformer can be used for T1.

The R.F. signal is modulated by turning potentiometer R9 in a clockwise direction from zero until the switch is turned on. The A.F. switch is set for either external or internal operation. The external position connects the modulator tube to the posts marked "External A.F. Source." A microphone or any other similar sound source may be connected to these posts. The internal position connects the other triode section of the 6C8-G tube so that it forms a two-stage audio oscillator. The pitch may be varied from 24 to more than 20,000 cycles per second by the 1-megohm potentiometer R9. This control serves as a tone adjustment when the external position is used. If it is desired to test A.F. equipment, the output may be tapped by turning the output switch to the A.F. position. The intensity is controlled by R10.

A type 35Z5-GT radio tube is used as a half-wave rectifier. The circuit operates from 120 volts A.C. or D.C.

PLUG-IN COIL DATA

Type "A" plug-in coils have the 350 mmfd. tuning condenser connected directly across the winding. Type "B" coils connect a small trimmer condenser, which is fixed at a certain capacity, in series with the tuning condenser. The latter type is used for the high-frequency coil, but can be used on any frequency where hand-spread operation is necessary or convenient.

The coils are wound in four different

Bob White, who is a Senior at Los Angeles High School, was born near Los Angeles on December 18th, 1927. During his Junior High School years he began experimenting and designing small unusual radio receivers. While



In Berendo Junior High of Los Angeles he wrote his first article for RADIO-CRAFT, entitled AN R.F. PRE-AMPLIFIER FOR BEGINNERS. It appeared in the issue of November, 1942. Since then other articles have appeared from time to time. Bob White has learned much about radio from magazines and books, and by experiments and independent research. At the present time he is a student of Radio Training Association of America. After completing High School, Bob hopes to continue his studies in college, and to follow a career in electronics and radio—preferably in research and experimenting.

styles. The first style consists of a self-supporting U.H.F. coil mounted inside a standard plug-in coil form. The second is a single-layer winding. The third is a layer-wound coil. The first layer is wound directly on the form. This winding is covered with an insulating paper which is doped in place. The next layers are wound so that the winding ends directly over the place where the one below started. A paper strip is always placed between each layer. The fourth is a jumble winding which is spread over the entire form. Winding data is given in the table at the end of this article. Winding is not critical, and coils may be adjusted in place.

The necessary data is given in the Plug-

(Continued on following page)

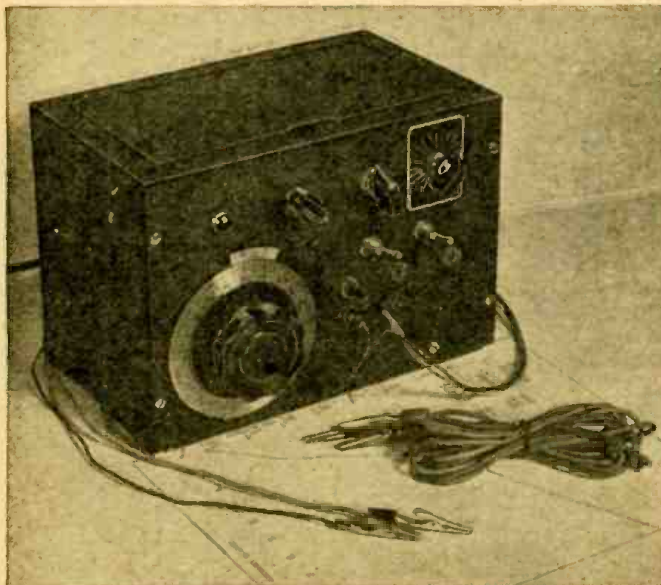

This commercial-looking signal generator has three sets of output jacks, one each for R.F., I.F.-A.F., and voltmeter.

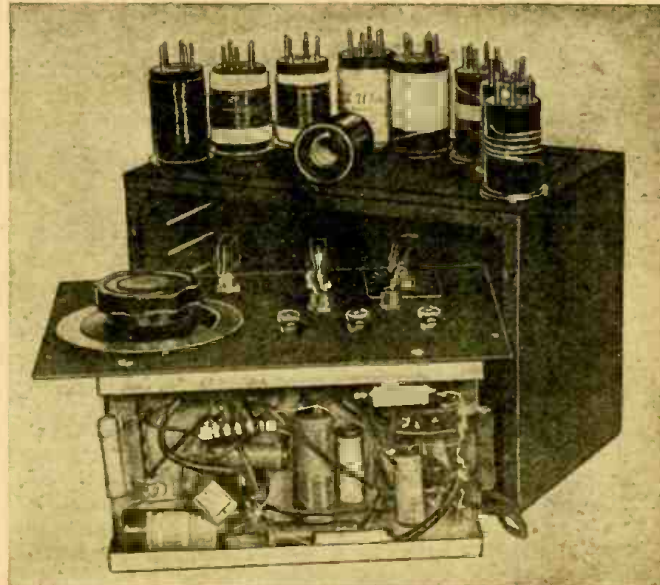

The generator removed from its case. Eight plug-in coils are used, in two series, for lower and higher frequent spectra.

In Coil Chart. The center of the coil is satisfactory for the tap if no other mention is made in the chart.

CALIBRATING THE GENERATOR

After the signal generator has been constructed and tested, it should be accurately calibrated. If no accurate signal generator

would be 150 kilocycles apart. The first harmonic would fall on 300 Kc., the second on 450 Kc., the third on 600 Kc., the fourth on 750 Kc., etc. Just subtract the smaller number from the next larger. Six hundred from 750 equals 150. All I.F. bands can be calibrated this way.

This process should be repeated for at least each five degrees of the dial from 100° to 0°. The results are recorded on a graph. The vertical lines represent the number of degrees, and the horizontal lines the frequency. When sufficient points have been marked on the chart, a curved line can be drawn through all the points. This will make it possible to set the oscillator to any desired frequency within the range of the coil and condenser.

The Broadcast band can be calibrated easily. Tune the receiver to a station which operates

on a known frequency. Then tune the oscillator so that it generates a signal on the same frequency. Record the various frequencies taken from known stations on a chart as was done with the other coils in the set.

The short-wave coils can be calibrated with the aid of harmonics. Set the oscillator to precisely 1000 kilocycles. Then tune in the first harmonic (2000 Kc.) on the short-wave range of the receiver. Remove the broadcast signal generator coil and insert a short-wave coil which will generate a signal that can be received without touching the tuner of the receiver. The oscillator should then be operating at 2 megacycles, the same frequency as the harmonic originally received. Record this frequency on a chart, and repeat this process using another harmonic. The harmonics from the oscillator, when tuned to 1000 kilocycles, will fall on 2, 3, 4, 5, 6, 7, 8, 9, 10, etc., megacycles.

A signal generator or test oscillator is a miniature transmitter whose operating frequency and intensity may be controlled at will. The fundamental use of the signal generator is to replace, for the purpose of testing, the signal received from broadcast stations.

R.F. stages, I.F. stages, and superheterodyne oscillators can be aligned through the use of the test oscillator and an output meter. The aerial and ground leads are disconnected from the receiver. A lead from the black output jack is connected to the ground post or directly to the chassis. A lead from the red output jack should be connected to the aerial post. In this test the red jack lead should be shielded so as to reduce interference from local broadcast stations. An output meter should be connected to the output stage so that the receiver can be accurately aligned by the visual method.

Receivers may be neutralized with the aid of a signal generator, a tube with an open filament circuit, and an insulated neutralizing tool. If the signal from the oscillator is heard in the speaker of the set with the dummy tube in place, the balancing condenser should be adjusted until the signal is cancelled out.

The R.F. oscillator is very useful for calibrating radio equipment. The A.F. oscillator may be used for testing A.F. equipment.

Automatic volume control circuits can be tested by comparing the output reading of the receiver with different A.V.C. tubes. A decrease in reading with a new tube shows that the old one is defective.

The selectivity of tuned circuits can be determined by noting the output reading when the frequency of the oscillator is changed a few degrees on either side of the point of resonance.

The frequency of resonance of a coil and condenser can be determined by opening the lid of the signal generator and placing the coil to be tested near the oscillating coil. A voltmeter should be connected to the meter jacks. When the oscillator is tuned to the frequency of the coil and condenser combination, a current will be induced into the coil. This will cause an increase in the oscillator plate current which will be indicated on the voltmeter.

The largest output from the R.F. oscil-
(Continued on page 276)

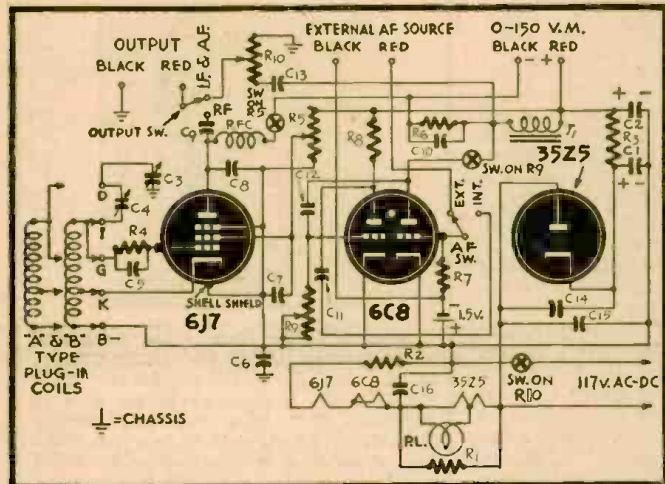

The generator has a switching device which places two condensers in series on the high-frequency bands. Audio tube is a multivibrator.

is available, the following systems can be used. Obtain an all-wave T.R.F. or superheterodyne receiver with an R.F. stage. If it has approximate calibration and a tuning indicator, fairly accurate results are possible.

The low radio frequencies, 560 to 65 kilocycles, are calibrated through the use of the harmonics generated by the oscillator. Plug in the coil to be calibrated. Disconnect the aerial and ground wires from the receiver. Connect the leads from the output posts of the generator to the ground or chassis and the antenna. Set oscillator controls so that it operates with a modulated signal. Turn the tuning knob to 100°. Several harmonics should fall within the broadcast band. If it is remembered that each harmonic is separated by a frequency equal to the fundamental signal, it will be very easy to determine the frequency of the oscillator. For example if the oscillator were tuned to 150 kilocycles, the harmonics

Left—Another under-chassis view, showing simplicity of wiring. Right—Top of chassis and inside of panel. The three controls are for intensity of oscillation, pitch of audio modulation and strength of output.

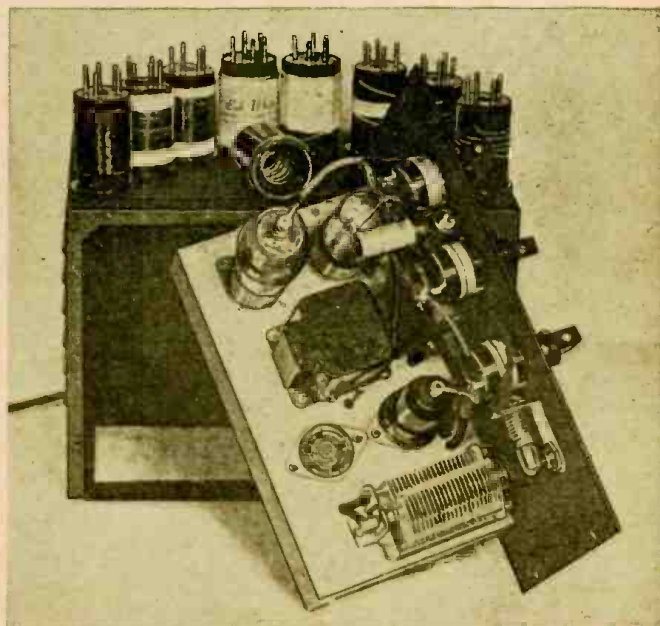

SHORTWAVE DIATHERMY

By JONATHAN M. OXLEY

FROM Hippocrates to Wagner von Jaureg, the story of the treatment of disease has been largely one of the application of the chemical and physical phenomena around us to produce curative effects. The use of electricity is another such attempt. The application of electronics, though a recent chapter in medical history, has been spectacularly effective.

Broadly speaking, electromedical and electrosurgical devices fall into two groups. The first group includes equipment used in the treatment of existing disorders; the second group includes equipment used for diagnosis. They may be further classified as follows:

- Group I. Electrodiagnostic
 - A. X-Rays
 - B. Electrocardiography
 - C. Electroencephalography
 - D. Fluoroscopy
 - E. Electro-optical devices
- Group II. Electrotherapeutic
 - A. Thermal Equipment
 - 1—Long Wave Diathermy
 - 2—Short Wave Diathermy
 - 3—Electropyrexia (artificial fever)
 - B. Galvanic Stimulators
 - C. Electrosurgical Instruments
 - D. X-Rays
 - E. Radium
 - F. Phototherapeutic Equipment

PHYSIOLOGICAL REACTIONS

While no extended discussion of the physiological effects of electricity is intended, or even possible in an article of this scope, it will be interesting to examine briefly the basic biological theory upon which much of our electrotherapeutic effects are based. Living tissue is composed of a complex chemical protoplasm in discrete units, the cells. These cells are bathed in a solution called lymph. Because of the dissolved salts in the cells, lymph and

blood, the body becomes subject to the basic phenomenon of electrochemical conductivity. Electrical currents produce two general effects when applied to the human body. The first is chemical, characterized by electrophoresis, cataphoresis and electro-osmosis. For readers interested in a detailed discussion of these phenomena, standard textbooks on physical chemistry and physiology are recommended. These changes probably cause changes in metabolism, and result in chemical transfers which are supposed to be the basis of the beneficial effects.

The second effect is a heat or thermal effect based on the conversion of electrical energy to heat energy. According to Joule's law: $Q = Ki^2rt$, the thermal effect produced would be dependent upon the current, the resistance and the time of application of the current. The body acts as the load in the circuit. According to one theory, the heat produced by the body is the result of hysteresis, a familiar phenomenon in transformers.

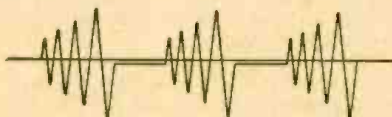

Fig. 1—Damped oscillations from spark gap.

The first type of effect, the chemical, is brought about by the use of direct current and low frequency alternating current. Devices of this kind have long been in use. One such is shown in Photo A. The thermal effect is the result of high frequency alternating current. In using high frequency alternating current, no chemical effects are produced because the speed of the impulse is so great. It is obvious from the above discussion that care in the use of electricity is highly important, since uncontrolled currents may cause violent chemical changes, injury and death.

Jonathan M. Oxley received his Bachelor's degree from Columbia University, supplementing it at the College of Engineering, New York University. Thereafter, he has spent most of his time getting information across to others, either by writing or teaching.



For several years he was associated with the New York City High School Division as a teacher of sciences. In 1942, as a Lecturer in the Techniques of Education he helped train future instructors at St. Louis University under the auspices of the Army Air Forces Radio Instructors Program. In 1943 he taught Radio and Electricity for the Army Air Forces Technical Training Command.

Since 1943, Mr. Oxley has been engaged as a consultant to write technical manuals for the Bureau of Ships, Quartermaster Corps, Corps of Engineers and Signal Corps, and has written articles for technical magazines and publishing houses.

SHORT WAVE DIATHERMY

Little did Hertz and Maxwell dream that their innocent oscillations would some day be used to "burn out" the aches and pains of mankind. It was not until the work of Nicola Tesla, in 1891, that possible uses in medicine were suspected. Then D'Arsonval, making use of currents of a million oscillations per second, proved conclusively that electricity could deal a death blow to diphtheria toxin. This was followed by the researches of Nagelschmidt and Schliephake. The latter, to the astonishment of himself and the entire world, succeeded in burning off a furuncle from his own nose, by the use of properly adjusted electrodes, with a dielectric between the electrode and his skin.

Short wave diathermy makes use of high frequency alternating current. The usual frequency employed is from 10 to 100 million cycles per second (wave length of from 3 to 30 meters). The heat produced in the body is the result of ohmic losses and dielectric hysteresis following Joule's Law. The oscillations are applied through electrodes through a gap of either air, felt, rubber or glass.

Modern short wave diathermy makes use of electromagnetic waves generated by one of two types of apparatus. The first is the spark-gap type, which produces damped oscillations. (See Fig. 1.)

The second is the electronic type which produces undamped oscillations. (See Fig. 2).

SHORT WAVE APPARATUS

The generator circuit is coupled to the closed "patient circuit" by means of two leads, each terminating in an electrode which is set in a dielectric. The patient, or part to be treated, is introduced between the two electrodes, which form a condenser. Thus, the patient is in the condenser field. Impulses enter the tissue under treatment and set up high frequency currents, which are converted into heat. Since short wave diathermy makes use of high-frequency oscillations, the equipment must

(Continued on page 280)

Photo A, left—Neurodyne, a low-frequency or direct-current electric therapeutic device. Photo B, right—Inductor diathermy apparatus. May use longer waves than type in Photo C. All photos courtesy Lee DeForest Laboratories

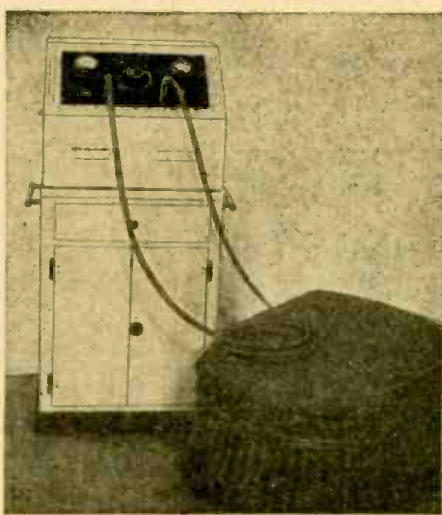

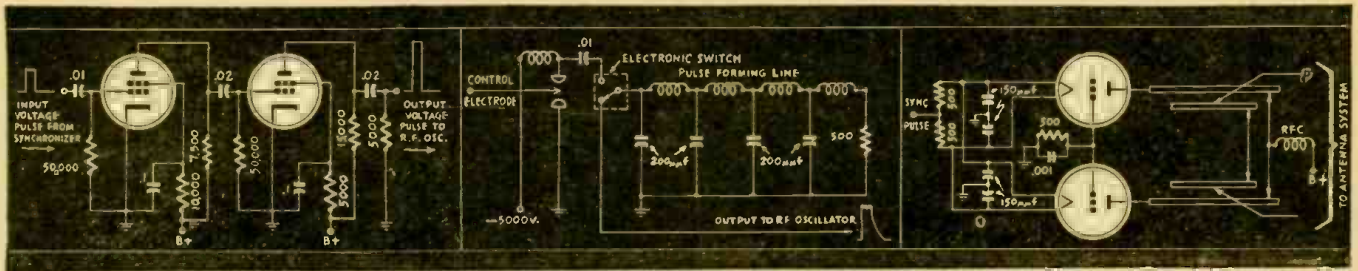

Fig. 1—Pulse amplification circuit. Fig. 2—Spark-gap oscillator and pulse-forming line. Fig. 3—Self-pulsing R. F. oscillator circuit.

ELEMENTS OF RADAR

Part II—Transmission of Radar Pulses—Radar Oscillators, Antenna Systems and Waveguides

By JORDAN McQUAY

TO obtain distinct and measurable echoes from distant targets, radar sets must operate with extremely high power output. Most sets have a peak power of 500,000 watts. Some radiate as much as a megawatt of U.H.F. energy.

Power is an important requirement of the radar transmitter. Because of the total energy radiated while the pulsed radar beam scans the sky or sea, only a small fraction strikes the target. An even smaller amount of energy returns to the set as an echo.

Radar's requirement of high output power at U.H.F. carrier frequencies led to the development of many new microwave R.F. oscillator tubes, some details of which are still on the Government's "secret" list. The group includes the G-E megatron "Lighthouse" tubes, certain high-frequency triodes, and, most important of all, the magnetron. A single magnetron is capable of producing oscillations at wave lengths of a few centimeters and with an output power exceeding 500 kilowatts.

Not all radar sets operate at such short wave lengths. There's a wide variety of types of R.F. oscillators used in radar transmitting circuits.

But the requirement of high output power is consistent with all radar carrier frequencies.

Modulated by the voltage pulses from the synchronizer, the radar transmitter does not oscillate continuously. Between pulses the transmitter is "shut down" for comparatively long periods of time. For this

reason, radar sets have a low *average* power output, despite extremely high power radiated during each pulse.

For example, a given radar set might transmit a megawatt of peak power during a 2 microsecond pulse. It would then be turned off for perhaps 500 microseconds, before again pulsing.

An important proportion exists between the average power and the peak power, the *pulse recurrence time*, and the pulse duration of a radar set. The relation is expressed by:

$$\frac{\text{peak power}}{\text{average power}} = \frac{\text{pulse recurrence time}}{\text{pulse duration}}$$

where the *pulse recurrence time* (in microseconds) = $1/p-r-f$.

In other words, the slower the pulse recurrence time the lower the average power; the greater the pulse duration, the higher the average power.

A low *average power* requirement of a radar set generally permits physically smaller tubes and components.

The primary power measurement in radar is the *peak output power*. All references to the power of a radar set should be assumed to mean peak power, the principal figure of radar operating merit.

The carrier frequency of a radar set may be anywhere within the range of 300 to 30,000 megacycles. Frequencies above 3,000 megacycles are preferred, permitting a much greater concentration of energy within the confines of a very narrow beam.

Another advantage: the radar antenna system will be smaller in physical size as the operating frequency is increased.

The voltage pulse from the synchronizer is primarily a controlling or modulating pulse. Although of appreciable voltage—50 to 500 volts—it may not have sufficient power to modulate the R.F. oscillator directly.

Occasionally, one or more stages of straight amplification may be used in the transmitter component. These are known as the modulator stage or stages. This additional amplification is usually performed by distortionless power amplifiers (Fig. 1). Push-pull stages may be used to amplify the modulating pulse.

Another method of modulating the R.F. oscillator employs a spark gap—either rotary or fixed—and an artificial transmission line. This is a pulse-forming line, in reality a form of time-delay circuit. It consists of a large number of pi-network sections of series inductances and shunt condensers (Fig. 2). When the arc discharge between the two firing electrodes is applied to the pulse-forming line, the burst of energy travels to the low-resistance termination, and is reflected as a similar pulse but of much higher voltage. By suitable

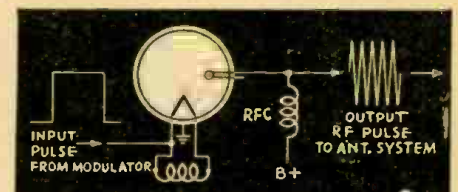

Fig. 5—Basic magnetron oscillator circuit.

electronic switching, the pulse of greater amplitude is applied directly to the R.F. oscillator.

Firing of the spark gap can be controlled by introducing a voltage of the required p-r-f to the control electrode of the gap.

Principal advantage of spark-gap modulation is that modulator tubes are unnecessary, thus eliminating a source of high current drain on the power system.

One type of radar transmitter combines the modulator and R.F. oscillator stage. This is the simplest type of transmitter, known as the self-pulsing oscillator. The circuit (Fig. 3) uses two triodes in push-pull and is something of a Hartley oscillator with the carrier frequency determined by the tuned-rod tank circuits. The U.H.F. energy is produced in pulses due to grid-blocking action.

A slight modification of this circuit—when the grid and plate circuits are coupled more tightly—is sometimes known as a *squegging oscillator*.

The self-pulsing oscillator is generally used only at the lower radar operating frequencies—about 300-500 megacycles. Oscillations at frequencies very much higher are too difficult to maintain and control.

Some stabilization may be introduced by feeding a synchronizing pulse—of the re-

(Continued on page 286)

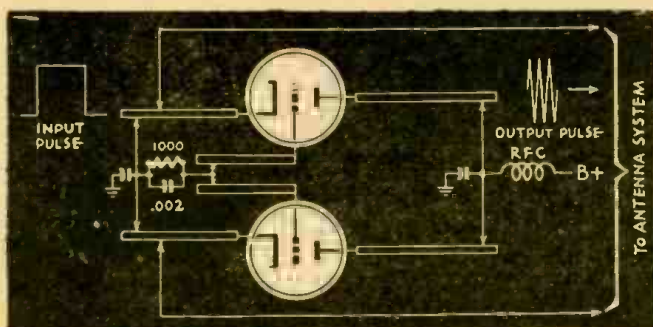
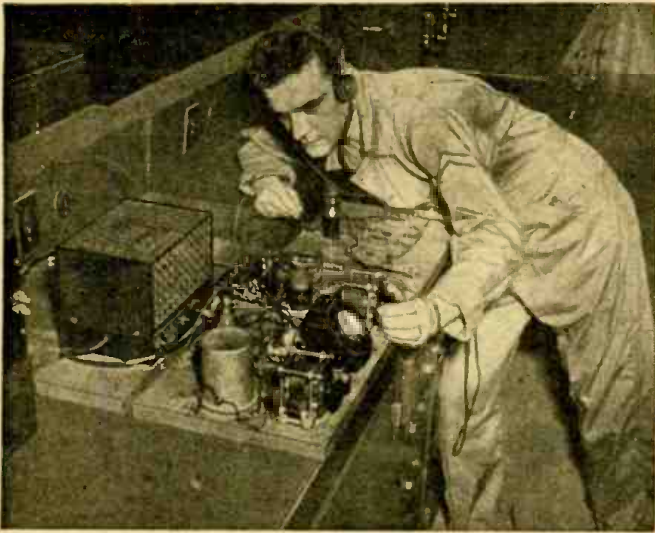

Fig. 4—A tuned-line push-pull ultra-high-frequency oscillator.



The same qualities required in Army-Navy radio servicing demonstrated in the photo at left, can be used on the civilian job shown at right.

RADIO OPPORTUNITIES

Electronic Careers Are Open for the Returning Serviceman

By E. A. WITTEN

RADIO and electronics offer one of the most promising fields for the returning GI. Many of those in the service have had invaluable training in radio and radar, but lack the necessary contacts in civilian life. Others would like to break into this field, but are undecided as to where they fit into this picture. The newcomer is at a loss as to what radio and electronics has to offer. All these factors taken together should spell out confusion—and it certainly does!

The following list of electronic fields, taken from Brigadier General David Sarnoff's booklet, "Opportunities in Radio & Electronics for Returning Service Men," serves to show the scope of electronics; most of these subjects are capable of supplying at least thirty different specialized jobs directly, and dozens more indirectly:

Acoustics	Magnetrons
Antennas	Marine-Radio
Automatic Gun-Fire Controls	Microphones
Aviation-Radio	Miniature Tubes
Cathode-Ray Tubes	Non-reflecting Glass
Chemical and Physical Effects of Microwaves	Phonograph Recording
Circuits	Phosphorescent Materials
Electron Microscope	Photoemission
Electron Tubes	Point-to-Point Radio
Electronic Clocks	Pulse Signalling Power
Electronic Counters	Radar
Electronic Time Measurers	Radio Relays
Facsimile	Radio-Electronic Heat Detectors
Facsimile Duplicators	Radiophotos
Frequency Modulation (FM)	Railroad-Radio
Fundamental Research	Sound Broadcasting
High-speed Scanners	Sound Recording
Industrial and Household Applications of Radio Frequency Heat	Super-High Frequency Oscillators
Lenses, Glass and Plastic	Supersonics
Loudspeakers	Television
	Television Optical Systems
	Wave Propagation
	Wired-Radio

These are merely some of the closely allied fields open to the electronic aspirant. Actually, radio and electronics can offer a job, directly or indirectly, to practically any type of person doing many types of work, often entirely dissociated with radio-electronics. Artists, for example are needed in radio—to sketch designs for new appliances, to draft circuit diagrams, indeed to illustrate this very magazine.

From Artist, you can go right down the alphabetical list to Z. While, at first glance, this might appear to be an extreme claim, sober investigation reveals it to be an understatement. The broad general field of radio-electronics takes in a good deal of territory.

Television serves well to illustrate the point. The industry is rapidly expanding, yet it is in a perpetual state of flux and change. It is sorely in need of skilled, semi-skilled, and unskilled help. In this industry, as in most, qualifications determine the job. According to Miss Judy DuPuy, former radio editor of the newspaper *PM* and one of the authorities in the field, men (and women) are needed in engineering departments, program departments, in sales, guest relations, research, art, promotion and advertising; as actors, engineers, technicians, stagehands, writers, station managers, directors, producers and production assistants—all are needed. For the person who wants to get in on the ground floor in television, any one of these jobs provides the key. The lock to fit that key will appear in the natural course of events.

The main drawback is that salaries are low—nothing or as little as they can possibly pay. The reason is that many people wanting to obtain a foothold in this field are willing to work for practically nothing. The studios are training their own help to reduce cost, since they can pay an unskilled but promising person a limited salary as an apprentice while learning. Television studios are still in the process of "getting started." Large amounts of money are being paid out each month but there is no incoming revenue to balance the books. As a result, the budget has had its belt tightened several times. The "squeeze" affects salaries first. The willing newcomer to television should begin "knocking on doors (of studios) and hope for results."

Radio broadcasting and FM stations offer a similar scale of opportunities. For

every position requiring technical specialized knowledge there are two or three that are only in need of persons with that God-given quality, common sense. (In some cases, the technical knowledge seems far easier to obtain than common sense.)

NON-TECHNICAL JOBS IN RADIO

Non-technical and semi-technical positions for women (or men in most cases also) include writers who are badly needed by the studios, scenario designers, studio set arrangers, producers, control room personnel, etc. At present, the hue and cry for writers has led to an interesting scale of "wages." A junior staff writer gets no lower than \$50 a week; a full-fledged staff writer a minimum of \$75. Staff writers can also earn extra money by free-lancing. Well-known free-lancers earn from \$250.00 to \$750.00 per half-hour script. An unknown writer will get from \$100.00 to \$150.00 for the same effort and can earn a minimum of \$125.00 a week writing fifteen-minute daytime serials.

The table shows some of the employment possibilities and requirements in radio and television. The salaries in radio are usually higher, in proportion to the experience required, responsibilities held, and length or degree of service.

Industrial electronics is another rapidly-expanding field that requires the services of persons with various degrees of skill and knowledge. This field was covered in the August, 1945, issue of *Radio-Craft* in the article, "Factory Radiomen." Marine and aviation radio were discussed in the February, 1945, issue in the article, "A Primer of Aviation Radio."

Supersonics, electron microscopy and facsimile are three more promising branches of electronics. The choicer positions are open to the technical or executive type. The beginner will find it hard sledding before he can climb into one of the top positions, but it can be done—it has been done—and it isn't necessarily a Horatio Alger story.

According to some of the more optimistic estimates, the industry will increase its pre-

(Continued on page 267)

Service Sans Instruments

Practical Methods of Tracking Down Trouble Without Equipment

THE writer has seen many articles written on how to service radio receivers with the aid of various test equipment, but he cannot recall having read anything on servicing *without the use of any equipment*. The just-concluded struggle has taught us that it is sometimes possible and even necessary to work with little or no apparatus. There will be some, no doubt, who will look askance at these methods and denounce them as "screw driver" tactics. In such cases, the author will defend himself to the last drop of his ink. To apply what follows, one must know his radio theory and be conversant with radio circuits in general.

Only those defects which are most likely to occur will be taken up in what follows:

Let us assume for sake of illustration that you are confronted with a "dead" receiver; the trouble could be any place between antenna post and voice coil. Further, assume that the circuit hook-up conforms to that shown in Fig. 1. The only service equipment available for our work is a screw driver. A signal generator may be needed when it is found that the owner decided his set had a few loose screws that needed tightening up—the screws being located on I.F. transformers. For the present, assume that the alignment screws have not been molested.

The first thing to suspect is of course the tubes. Since we have no tube tester, we must devise some system to determine if the tubes are in working order. Plug the receiver into the 115 volt A.C. receptacle. The tubes should light up. It will be impossible to see whether or not they light if they are of the metal type. In such a case, try substituting their glass equivalent or a reasonable facsimile. In other words, a 6K6G or a 6V6G may be used in place of a 6F6, 6L6, etc., for test purposes. Any tube that doesn't light should be replaced, of course.

During the plug-in operation stand ready to unplug the set should the rectifier tube (or any other tube for that matter) show signs of color. Suppose upon turning the receiver on, the plates of the rectifier get red hot. This would indicate a short-circuit existed from point "X" to ground. An inspection of Fig. 1 reveals that C_1 would cause this condition if it were shorted. If it is at fault, the receiver should become operative when it is disconnected from the circuit; however, a loud hum will result. Should the filter choke, CH, become shorted the plates of the 5Y3 may show color

By VIRGIL R. SEARS

after a few minutes of operation. It is doubtful whether a short at C_2 would overload the rectifier to such an extent that it would show signs of color. In this case CH would heat up to a dangerous degree within a very short time. In making all of these tests do not leave the receiver on too long at one time. Work fast and with care. A short at C_2 may be found by shorting momentarily from point X to ground and repeating at point Y. If we get a strong spark at X but none at Y, disconnect C_2 . If still no spark, suspect an open in the filter choke. Disconnect the rectifier at point Z. From this we can ascertain whether or not CH is open. We should get a strong spark each side of CH providing that it is not open.

Some insist that shorting the high voltage to ground as pointed out above is detrimental to the receiver. The writer is not of this opinion for he has done this many times without any ill effects whatsoever. However, it should be made plain that this should be done only momentarily.

In our set-up, an open at R_1 would not be evident without test equipment. The receiver would still perform. In some receivers this resistor or a part of it furnishes bias for the set. Should an open develop in this case, the receiver would be inoperative. If we suspect the resistor of being open, disconnect it at point Z and short the end of the resistor to point Z; a spark should be seen. The spark ordinarily will not be very large.

The writer has never seen a shorted resistor at the point of R_1 . If it were found to be shorted, it may be found by the same procedure as outlined above for a short at C_2 . If C_1 and C_2 should lose part of their capacity, a hum will develop, the magnitude of which will depend upon the amount of capacity lost. In some cases severe distortion and oscillation may develop.

One word of caution before leaving the rectifier section—never replace a dead rectifier tube without questioning the condition of C_1 , C_2 and CH. Such practice will prove expensive in terms of rectifier tubes.

Now that the rectifier section is not at fault, let us proceed to the power output stage. This stage is marked 6F6G in Fig. 1.

We will start at the speaker and work backward to the antenna. The first thing to confront us is the voice coil of the

speaker. Should no sound whatsoever come from the speaker the fault is either in the high voltage supply (no voltage) or the speaker is defective. The latter includes the output transformer.

An open voice coil can usually be found if it is the only defect by tuning the receiver to a strong station and advancing the volume control. The lamination of the output transformer will vibrate and the station may be heard faintly when the ear is placed near the transformer. Care should be taken not to prolong this test as the insulation on the output transformer may puncture. If the secondary side of the output transformer is open, it can be found by the same procedure as outlined above for an open voice coil. With the primary of T_1 open, there will be no voltage on the plate of the 6F6 tube. In this case, the screen grid will turn red, and there will be no spark when the plate of the tube is shorted to the chassis. It is usually possible to detect an open primary of T_1 before removing the chassis from the cabinet.

An open at R_2 may be determined by shorting from the cathode to chassis. The set should operate, though not well. If you suspect C_{11} of being open shunt it with a good condenser. If it is shorted distortion would develop and shunting it with a good condenser would not clear up the trouble. If R_2 opens, the grid would become so negative in a short period of time that the grid would block.

From an inspection of the diagram, it will be obvious that a positive grid would result should C_3 develop a short circuit. The set would develop a case of severe distortion or may fail to perform altogether. One case the writer recalls was a receiver that would play for about 30 seconds and die away. It was found that the control grid of the output tube was several volts positive. Observation showed the grid was red hot.

If all output stage parts are in order we should hear a faint click if the grid of the 6F6 tube is touched with a screw driver. Next touch the grid of the 6Q7; in this case, the sound in the speaker should be louder. If we get no sound, we must stop and search for the trouble in this stage. Try a new tube. Short from plate to chassis for a second. The voltage here will not be very high as R_1 is usually large. Should this portion be in order, advance the vol-

(Continued on page 261)

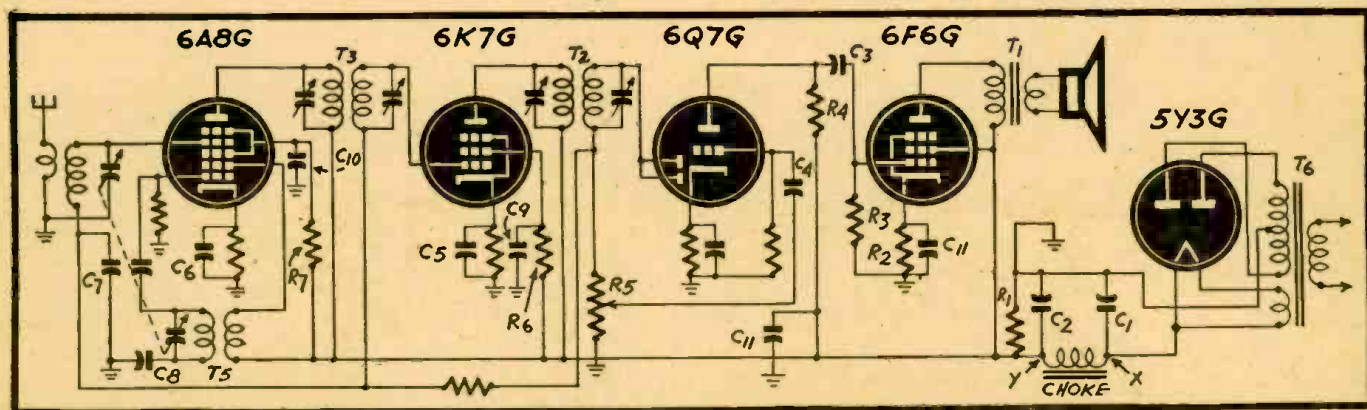

Fig. 1—This schematic is typical of many used in moderate-priced radios. Slightly different techniques will work on any radio receiver.

A. C. Voltage Measurements

By OSCAR E. CARLSON

THE use of D.C. millimeters and copper oxide rectifiers to measure A.C. voltages has been in general use since the early 1930's. It is unfortunate, however, that very little analytical information on such rectifier operation in meter circuits has been published in books or magazines read by the large majority of the users of such equipment, the Radio Serviceman. It is the intent of this brief article to summarize some of the data that will tend to clarify these circuits for the Serviceman and others interested in low frequency voltage measurements.

A rectifier is by definition "a device that allows current to flow through it more readily in one direction than in the other." Note that some current may flow in both directions; in other words, a rectifier isn't a completely uni-directional current flow device.

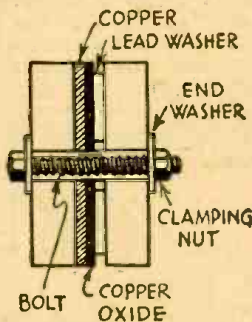

Fig. 1—How a copper-oxide rectifier is made.

The copper oxide form of rectifier is shown in Fig. 1. Such a rectifier consists of a disc of copper oxide held in contact with a copper disc. Lead washers are used between brass plates to give even surface pressure.

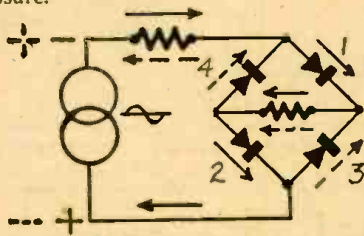

Fig. 2—Current flow in the bridge rectifier.

Figure 2 illustrates a basic circuit using four rectifier sections in the familiar bridge rectifier circuit. The solid line and dotted line arrows indicate direction of maximum,

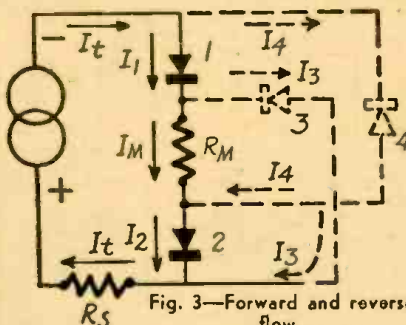

Fig. 3—Forward and reverse flow.

or forward, current flow during the two half cycles of a complete alternation of A.C. input voltage.

If we consider the full current flow, that is, both forward and reverse current, we have a circuit condition during a conduction cycle as seen in Fig. 3. It is seen that the total current is slightly greater than that current which flows through R_m , which we may consider as the resistance of a D.C. millimeter inserted at that point.

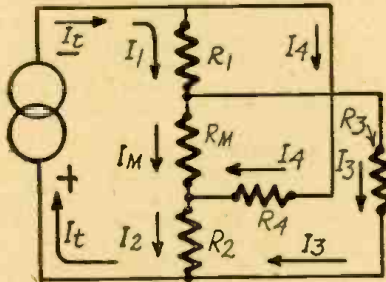

Fig. 4—Equivalent circuit, bridge rectifier.

If we now replace the rectifier units of Fig. 3 with resistors of the same value, we have the circuit of Fig. 4 and a current distribution as indicated thereon. The current equations are:

$$\begin{aligned} I_t &= I_1 + I_2 \\ I_1 &= I_t - I_2 \\ I_m &= I_1 - I_3 \\ I_2 &= I_m + I_3 \\ I_t &= I_2 + I_3 \end{aligned}$$

From this we see that $I_m = I_t - I_2 - I_3$ (1).

Thus the current that flows through the meter M in a circuit such as Fig. 2 is the current from the voltage source minus the shunt current through the two rectifier elements which will conduct during the next half cycle of input voltage.

RECTIFIERS NOT LINEAR

The value of the effective resistance of each rectifier unit varies for both the conduction and non-conduction half cycle with the current flowing through the unit. Therefore a circuit such as that of Fig. 2 offers a varying resistance as a function of the applied voltage to be measured. This does not allow for a linear voltage calibration of a D.C. millimeter to indicate applied A.C. voltage unless the series multiplier R_s is very large compared to the effective resistance of the meter and rectifier units. The effective resistance of each rectifier unit when conducting may vary from 2500 ohms for .1 milliamperes to 600 ohms for 1 milliamperes. Thus for a linear scale-calibration R_s should be such that the variations of the other resistance is negligible. This should be in the order of 50,000 ohms.

Since the resistance per volt of the circuit when using a one-milliamperes meter on such a circuit is less than 1000 ohms per volt due to the shunt current of the rectifiers, this would mean a full scale reading of approximately 50 volts to assure linear calibration.

The D.C. meter will respond to the rectified current in proportion to the average of that current. We are interested in a calibration for R.M.S. or effective values of a sine wave of A.C. voltage. The average value of a half wave sine wave is .636 or 90% of the effective value of .707 of the peak. Thus if there were no shunt current whatsoever we would for A.C. meas-

urements have a circuit sensitivity of 1000 ohms per volt times .9, or 900 ohms per volt. Due to the shunt current this is further reduced since more current flows from the source and through the voltage multipliers than through the meter. This may be readily seen by re-examination of Fig. 4 and the current formulae for same. This shunt current is usually of sufficient average magnitude to give us an effective circuit sensitivity for A.C. measurements with R.M.S. calibrations of approximately 800 ohms per volt.

Let us refer again to Figs. 2 and 4 which are identical, or, equivalent. As we have seen R_1 , R_m , R_2 , R_3 and R_4 as an effective value of resistance is in series with R_s , the multiplier, or current-limiting resistor. A subdivision of voltage is thus accomplished. Subdivision of A.C. voltages, or current limiting for a given applied voltage, may be achieved in A.C. circuits by reactance as well as by resistance.

CONTROL WITH CAPACITORS

In Fig. 4 any variation in resistance of the meter and rectifier combination adds or subtracts directly to the previous algebraic sum of the value of R_s and circuit resistance. But suppose that we replace R_s with a capacitor of such reactance that at the frequency of measurement X_c is equal to the value of R_s . A variation in rectifier resistance due to current variation does not add algebraically to X_c but geometrically, or vectorially. The circuit is now that of Fig. 5 which is equivalent to that of Fig. 6.

The impedance seen by the source of A.C. voltage is now:

$$Z = \sqrt{R^2 + X_c^2} \quad (2)$$

For a given frequency the reactance of the series capacitor is constant and independent of current flow through it. But due to the vector addition of R and X_c , if X_c is several times larger than R , any variation in R results in only a small variation in Z and thus we may achieve a linear calibration for a lower value of full scale deflection voltage than for a resistive multiplier. Fig. 7 illustrates the change in Z that occurs with R doubled from a value at which it was equal to 1/10 of X_c .

On this same basis the multiplier resistance used in the D.C. circuit of a multi-tester may be used for the A.C. scales by

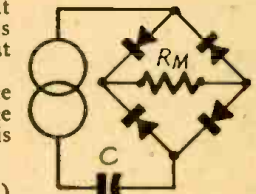

Figure 5

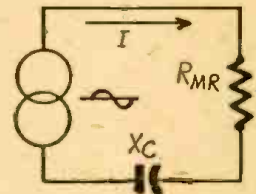

Figure 6

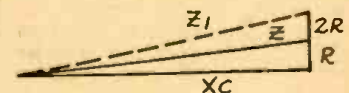

Fig. 7—Resistance change has small effect.

shunting a capacitor across each of such value that the effective Z is the proper

(Continued on page 275)

clean, and easily legible, perhaps not much fault can be found. (We speak of writing in ink.) It is amazing in these days of progress that in every batch of applications, penciled letters are still to be found; they are in 99 per cent of the cases WB material. The busy official prefers a neat, crisp, typewritten letter, preferably on the applicant's own stationery.

That is another point on which we may expand somewhat. If you are looking for a position these days—and by position we mean just that, not a minor job—it will pay you to invest in a letterhead which has your own name neatly printed on top. If you have a telephone, it should be listed too. If you are an ex-serviceman it is an excellent idea to have the discharge emblem with the eagle printed in the upper right-hand corner. This immediately signals to a possible employer that you were in the service without your having to go at length into your military record. It is dignified and flags your letter immediately as that of an ex-serviceman.

Incidentally, the extra dollar that you invest in good printing and good paper, will pay handsome dividends. These are all little but important points to remember. *You are selling yourself* to a prospective employer who knows nothing about you and who can only judge by one thing, *your letter*.

Again, many letters, even when they are written on the best bond paper and typed neatly, will be scanned with lifted eyebrows, if the letter contains a number of grammatical or just plain, careless mistakes. If you make an application for a position, the letter **MUST** be perfect to get *real attention*. Therefore, re-read it, not once, but *three times*. If necessary re-type it, or re-write it—this pays dividends too.

6. Complete Information. No matter how well a letter is composed, no matter how much thought you gave to its preparation—it will fall flat if you do not give full information about yourself. Every employer, as a matter of routine, wants to know the following:

Your age, whether single or married, your weight, your educational background (degrees if any), and your general experience in the field. Follow this with a list of former employment, and any additional information such as former earning capacity, etc.

It sometimes pays to state what other aptitudes you have. For instance, you might make an application as a technician with an amplifier concern making sound equipment. If by any chance you are a musician, or amateur musician, play the violin, etc., that information is valuable because in sound the prospective employer frequently requires someone who has musical ability or understands music. Similar expressions in other positions might sometimes turn the balance in favor of the candidate who has some aptitude that another might not have.

7. Processed information. Many applicants take the easy way in making applications today. They use their visiting card, or write a few words on a small slip of paper and attach it to a processed record of experience, then mail it to the advertiser. By processed, we mean where the applicant gives a complete list of experience, aptitude, etc., often running anywhere from two to ten pages. If the processing is done neatly and legibly, no fault can be found. But all too often the work is done by hectograph, mimeograph, or otherwise processed in such a manner that it becomes most difficult to read it. Frequently there are illegible fifth or sixth carbon copies on tissue paper. All this is deadly, although many applicants don't realize it.

If the record of the applicant is processed carefully with good workmanship no fault

SO YOU WANT A RADIO POSITION!

(Continued from page 233)

can be found. *Indeed, it is a good way to make an application.* The best process is multigraphing, or by the Hooven letter method. While the application can be printed, this is more unusual, besides it is expensive and does not serve a purpose. Clean good typewritten copy is still the best method and is preferred by all employers.

8. High-Pressure Boys. Very frequently persons with otherwise sound mental equipment think that high-pressuring an advertiser will get the job quicker than anything else. They will send telegrams such as the following, actually received by an advertiser recently.

"Do not look any further, I am the man for the job. Have all the qualifications. Phone or write at once."

In most cases this kind of a high-pressure method will not get the job, simply because not enough information is given. It is also a "blind" application and few employers fall for it. It usually is not even answered.

Other missives in the same category are those that are elaborately prepared in col-

ors and usually mounted on cardboard to get attention. There is nothing wrong with such unusual applications, except that in most of them the applicant does not get down to brass tacks and only gives sketchy information about himself. It too goes into the WB.

Other applicants of similar ilk send a letter which arrives by express or parcel post and to which is attached a large scrapbook or other voluminous data setting forth the applicant's performances heretofore. This is not a bad idea because employers are usually impressed by past performance and by actual samples of the candidate's work. But it must again be stressed that such applications fall down if the writer does not give complete information about himself. If such is supplied the unusual method of presentation, will get many jobs.

9. The Doughboys. This class is primarily interested in the money end which is first and uppermost in their mind. When it comes to service and ability, they are not so much interested. Here is a verbatim example:

"If you cannot pay \$3,500.00 a year, or over, do not read any further."

"Applicant also would expect a five-day week."

Then follow a few scant lines of vague information about the applicant who no

(Continued on page 254)

1. James R. Doe 145 East 73 Street New York 23

DO YOU HAVE A JOB FOR ME?

A five-minute check list to save the time of busy employers, advertising managers, and personnel managers.

Do you need a man who:

Check here

- | | |
|--|--------------------------|
| 1. Can write fluently in a plain way | <input type="checkbox"/> |
| 2. Can make rough advertising layouts | <input type="checkbox"/> |
| 3. Has lots of ideas, some good, some bad | <input type="checkbox"/> |
| 4. Can prepare publicity and direct mail pieces | <input type="checkbox"/> |
| 5. Can do research, if not too technical | <input type="checkbox"/> |
| 6. Can make abstracts or condensations | <input type="checkbox"/> |
| 7. Knows a little about type, printing, paper | <input type="checkbox"/> |
| 8. Is willing to do detail work | <input type="checkbox"/> |
| 9. Will study hard to learn business he enters | <input type="checkbox"/> |
| 10. Is not a genius, but IS a productive employee | <input type="checkbox"/> |
| 11. Wrote and sold advertising (five years) | <input type="checkbox"/> |
| 12. Was in the Army (three years) | <input type="checkbox"/> |
| 13. Studied radar at Temple University (one year) | <input type="checkbox"/> |
| 14. Overseas, 8th Air Force, radar work (one year) | <input type="checkbox"/> |
| 15. Is now 36, in excellent health, presentable | <input type="checkbox"/> |
| 16. Available now, to start at \$50 a week net | <input type="checkbox"/> |

(For details see succeeding pages)

World-Wide Station List

Edited by ELMER R. FULLER

WITH this issue we are bringing you the second part of the station log listed geographically; the third and final section will appear in the February issue. In the March issue, you will again find the old familiar log according to the frequency used. We hope that the amateur situation will be cleared up soon and that part of this department can be devoted to them as it was previous to the war. At the time of going to press for this issue, the two and one-half and the ten meter bands are in use, and good results are being obtained on ten meters (considering the possibilities). As far as we know only the U. S. hams are on this band, and we have heard all districts here; this is about the limit on what can be done. Reports on the ham bands will be greatly appreciated, and we assure you of some space for ham radio.

New stations are popping up all of the time, and many new Europeans and Asiatics are being heard. Rangoon in Burma has been reported on several frequencies, usually heard on 11.860 megacycles and on 6.040 megacycles. Radio Andorra is

being heard from noon to 5:30 pm on 5997 and 9.330 megacycles. EAJ43 is in the Canary Islands, and is heard 5:06:15 pm on 7.570 megacycles. Oslo, No. way, is being heard again on 9.540 megacycles. They are heard best at 1:45 to 7 am, and 10 am to 4 pm, using the call LKJ. A Spanish Morocco transmitter is being heard at 5 to 6:15 pm on 6.095 megacycles. The station is located at Tetuan.

Information and reports on reception of the Indian stations may be sent to "Government of India Information Services, 2107 Massachusetts Avenue, N. W., Washington 8, D. C." Reports on the Australians may be sent to the "Australian News and Information Bureau, 610 Fifth Avenue, New York City."

New Listening Post Certificates will be in the mails by the first of the year, and we hope to receive the fine support from our observers we have during the past year. Your co-operation during the war was the only way we could keep our log as up-to-date as we did, due to lack of correspondence with the stations themselves. Now we need those reports to learn what

is being heard and where. Also, this is our chief source of information concerning the ham bands.

A letter from England advises us that it will probably be some time yet before the British hams are back on the air; they will in most cases be using new equipment as they sold theirs to aid in the war effort. Several of the South American hams are being heard nightly on the forty meter phone band, but they are badly QRM'ed by the CW and commercial phone stations found there. The FCC seems to give little notice when another amateur band is going to be opened up, as we had but ten days to get the ten meter rigs dusted off and the antenna up; but several of the boys got it done by working hard and were there on the first day.

Well, we wish you all a Happy New Year, and the best dx season ever enjoyed. Best of luck, and let's hear from you and have your reports on what you are hearing; and what you would like to read in this department. Also, we would like to hear about new receivers and antennae obtained since materials have been made available.

Location	Station	Frequency and Schedule	Location	Station	Frequency and Schedule	Location	Station	Frequency and Schedule
ENGLAND								
London	GWB	9.550	London	GVZ	9.640 North American beam, 4:15 to 11:45 pm; New Zealand beam, midnight to 4 am	London	RH	9.825 North American beam, 4:15 to 11:45 pm
London	GSC	9.580 Central and South American beams, 4:15 to 9:15 pm; Indian beam, 8 to 8:15 pm	London	GWP	9.660 African beam, 11 pm to 1:15 am; Far East beam, 11 pm to 3:45 am; North African beam, 1 to 2:45 am	London	GRU	9.915 African beam, 12:30 to 3:30 pm; 3:45 to 4:45 pm; Indian beam, 11:15 am to 12:15 pm; Mediterranean beam, 3:45 to 4:45 pm; North African beam, 12:30 to 3:30 pm
London	GRY	9.600 African beam, 12:15 to 4 pm; Near East beam, 2:30 to 4 pm; Middle East beam, 11 pm to 1:45 am; Australian beam, 11 pm to 3 pm	London	GWT	9.675 African beam, 1:45 to 2:15 pm; Canary Islands beam, 1:30 to 2:45 am; 2:15 to 2:30 am; 3 to 3:30 pm; European beam, midnight to 2 am; 5 to 7:30 am; 10:15 am to noon; 12:30 to 1:30 pm; 2:15 to 4 pm	London	GRG	11.680 Far East beam, 9 to 10:15 am; Middle East beam, noon to 2:15 pm
London	GWO	9.625 African beam, midnight to 1:15 am; Middle East beam, 12:15 to 12:30 am; 1:30 to 2 pm; 4:15 to 4:30 pm; European beam, midnight to 12:30 am; 1 to 2:45 am; 5 to 7:30 am; 10 to 11 am; noon to 1:30 pm; 2 to 5:45 pm	London	GRX	9.690 Australian beam, midnight to 4 am	London	GVW	11.700 African beam, 10:30 am to 4 pm
						London	GSD	11.750 African beam, midnight to 3 am; 10:30 am to 4 pm; South American beam, 4 to 9:15 pm; Mediterranean beam, 2 to 3 am; 4 am to 4 pm; North African beam, 2 to 3 am; 4 am to 3:30 pm
						London	GVU	11.780 Indian beam, 11 pm to 1:15 am; Australian beam, 11 pm to 1:15 am; European beam, 5 to 7:45 am; 10:15 am to 1:15 pm; African beam, 5:30 to 6:45 am; 7:15 to 7:45 am; 10:30 to 11 am; 11:30 am to 1 pm
						London	GWH	11.800 African beam, 1:45 to 2 am; 7 to 7:15 am; Canary Islands beam, 1:30 to 1:45 am; European beam, 1 to 2 am; 5 to 7:45 am; 10:15 am to noon; 12:30 to 1:30 pm
						London	GSN	11.820 New Zealand beam, midnight to 1 am; African beam, 1 to 4 pm
						London	GWO	11.840
						London	GSE	11.860 Near and Middle East beams, 11:45 pm to 5 am; 1:30 to 2 pm; African beam, 3:30 to 4 pm; European beam, 11:30 pm to

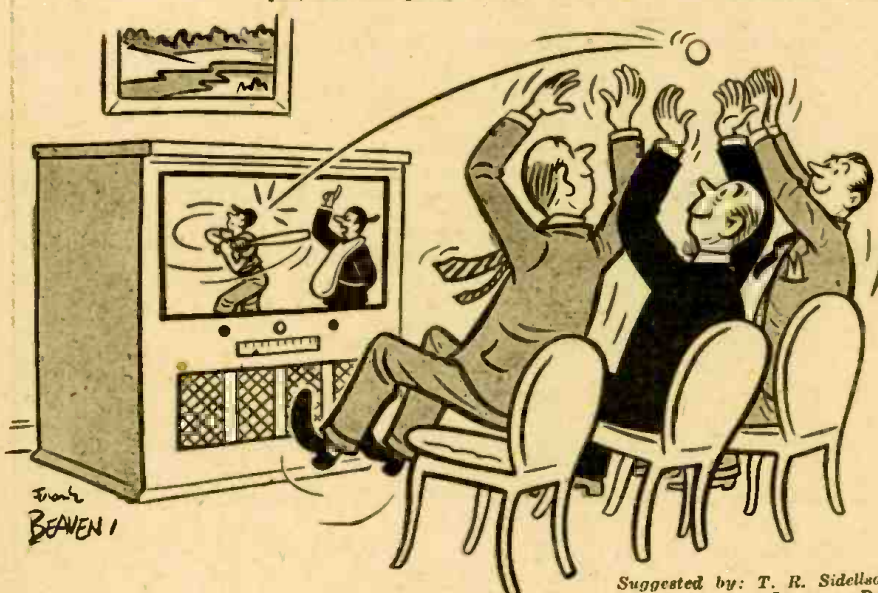

Suggested by: T. R. Sidellso, Luzerne, Pa.

(Continued on page 254)



Which for You—
SCREWDRIVER
 or **SLIDE RULE?**



Face the Facts . . .
You Must Train Now to Step Ahead
of Competition into a Good-Paying Job in Radio-Electronics
 —or be left behind because you lack the
understanding of new electronic techniques

CREI home-study courses are for professional radio-men only, and this CREI message is for those who are not afraid to face the facts! The bars are down on radio-electronics progress! You are facing a completely new era in the radio-electronics world. The war-restricted curtains of secrecy have been pulled aside, revealing each day momentous, revolutionary applications of new radio-electronic principles and theories, and their complicated circuits, equipment, individual parts, etc.

No matter what your past radio-electronics experience has been, no matter what your training you must start anew to add to your store of radio-electronics knowledge. You must keep pace with the new develop-

ments and ahead of competition if you expect to get ahead in this new world of radio-electronics—or even maintain your present position in the field.

How much do you know about U.H.F. Circuits, Cavity Resonators, Wave Guides, Klystrons, Magnetrons and other tubes? All these revolve largely around U.H.F. applications. And here is where CREI training can help you. In our proved home study course, you learn not only how . . . but why!

Let CREI train you now to trade that "screwdriver" for a slide rule. Do something about increasing your technical ability and advance to the better-paying radio jobs that offer security and opportunity. The facts are in the free booklet. Send for it today.

**Servicemen —
 Discharged Veterans**

CREI Residence Training
 Available Under
 Provisions of "G.I." Bill

CREI now offers Residence School courses in Radio-Electronics Engineering, Broadcast & Television Engineering and Broadcast & Television Servicing under the Serviceman's Readjustment Act of 1944 ("G.I." Bill.) Classes now in session. Enter at any time. Write for details.

WRITE TODAY FOR FREE 36-PAGE BOOKLET

"Your Opportunity in the New World of Electronics"

TELL US ALL ABOUT YOURSELF, so that we can intelligently plan a course best suited to your needs. If you have had professional or amateur radio experience—let us prove to you that we have something you need to qualify for a better radio job. To help us intelligently answer your inquiry—PLEASE STATE BRIEFLY YOUR BACKGROUND OF EXPERIENCE, EDUCATION AND PRESENT POSITION.



CAPITOL RADIO Engineering Institute

HOME STUDY COURSES IN PRACTICAL RADIO-ELECTRONICS
 ENGINEERING FOR PROFESSIONAL SELF-IMPROVEMENT

Dept. RC-1, 3224—16th Street, N. W., Washington 10, D. C.

Contractors to U. S. Navy—U. S. Coast Guard—Canadian Broadcasting Corp.
 Producers of Well-trained Technical Radiomen for Industry.

Member:] NATIONAL COUNCIL OF TECHNICAL SCHOOLS

PLEASE PLACE YOUR ORDER WITH YOUR REGULAR RADIO PARTS JOBBER. IF YOUR LOCAL JOBBER CANNOT SUPPLY YOU, KINDLY WRITE FOR A LIST OF JOBBERS IN YOUR STATE WHO DO DISTRIBUTE OUR INSTRUMENTS OR SEND YOUR ORDER DIRECTLY TO US.

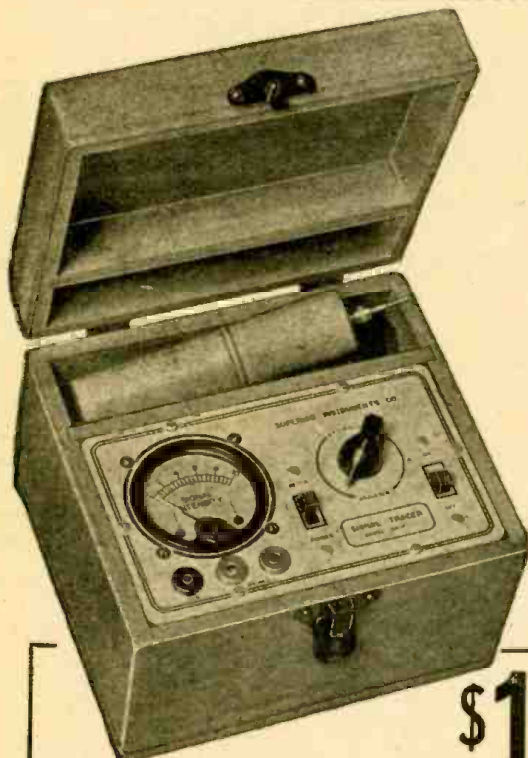

The New Model CA-11 SIGNAL TRACER

Simple to operate . . . because signal intensity readings are indicated directly on the meter!

Essentially "Signal Tracing" means following the signal in a radio receiver and using the signal itself as a basis of measurement and as a means of locating the cause of trouble. In the CA-11 the Detector Probe is used to follow the signal from the antenna to the speaker — with relative signal intensity readings available on the scale of the meter which is calibrated to permit constant comparison of signal intensity as the probe is moved to follow the signal through the various stages.

Features:

- ★ SIMPLE TO OPERATE — only 1 connecting cable — NO TUNING CONTROLS.
- ★ HIGHLY SENSITIVE — uses an improved Vacuum Tube Voltmeter circuit.
- ★ Tube and resistor-capacity network are built into the Detector Probe.
- ★ COMPLETELY PORTABLE — weighs 5 lbs. and measures 5" x 6" x 7".
- ★ Comparative Signal Intensity readings are indicated directly on the meter as the Detector Probe is moved to follow the Signal from Antenna to Speaker.
- ★ Provision is made for insertion of phones.

The Model CA-11 comes housed in a beautiful hand-rubbed wooden cabinet. Complete with Probe, test leads and instructions.....Net price

\$18⁷⁵

The New Model 450 TUBE TESTER

Specifications:

- Tests all tubes up to 117 Volts including 4, 5, 6, 7, 7L, Octals, Loctals, Bantam Junior, Peanut, Television, Magic Eye, Hearing Aid, Thyratrons, Single Ended, Floating Filament, Mercury Vapor Rectifiers, etc. Also Pilot Lights.
- Tests by the well-established emission method for tube quality, directly read on the scale of the meter.
- Tests shorts and leakages up to 3 Megohms in all tubes.
- Tests individual sections such as diodes, triodes, pentodes, etc., in multi-purpose tubes.
- New type line voltage adjuster.
- NOISE TEST: Tip jacks on front panel for plugging in either phones or external amplifier will detect microphonic tubes or noise due to faulty elements and loose internal connections.
- Works on 90 to 125 Volts 60 Cycles A.C.



SPEEDY OPERATION assured by newly designed rotary selector switch which replaces the usual snap, toggle, or lever action switches.

The model 450 comes complete with all operating instructions. Size 13"x12"x6". Net weight 8 lbs. **\$39⁵⁰**
Our Net Price.....

The Model PB-100 VOLT-OHM-MILLIAMMETER

Features:

- ★ Push Button Operation
- ★ Direct Reading
- ★ Housed in Portable Oak Cabinet
- ★ No External Source of Current Required

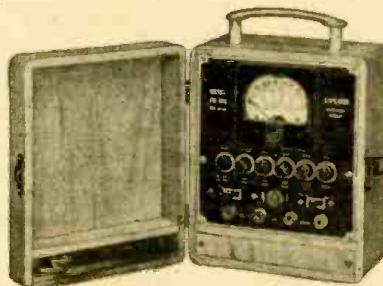

Specifications:

6 D.C. VOLTAGE RANGES: 0 to 5/25/50/250/500/2500 Volts
5 A.C. VOLTAGE RANGES: 0 to 10/50/100/500/1000 Volts
5 OUTPUT METER RANGES: 0 to 10/50/100/500/1000 Volts
3 D.C. CURRENT RANGES: 0 to 10/250 Ma. 0 to 2.5 Amp.
3 RESISTANCE RANGES: 0 to 10,000/100,000 Ohms, 0-1 Meg.
3 DECIBEL RANGES: -10 to +15; 0 to +35; +30 to +55.
Model PB-100 comes housed in a hand-rubbed oak cabinet, self contained battery, test leads and instructions. Net price..... **\$28⁴⁰**



SUPERIOR INSTRUMENTS CO.

Dept. R 227 FULTON ST., NEW YORK 7, N. Y.

**MOST —
OFTEN —
NEEDED**

RADIO DIAGRAMS

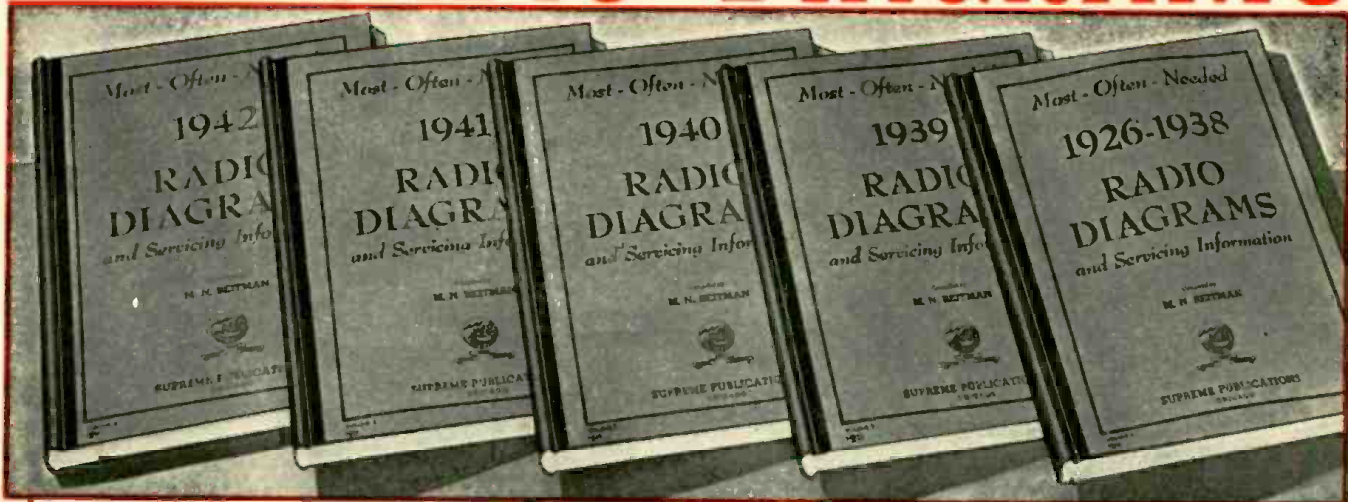

1942 4 Out of 5 Diagrams You Will Ever Need

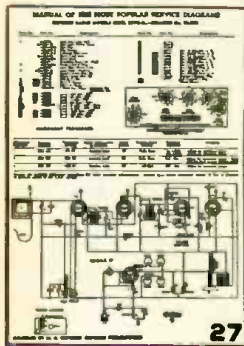

Find radio faults quickly. Make the needed repairs in any radio. Save time on every job. This large, new and inexpensive diagram manual has the circuit for every popular 1942 radio set. 4 out of 5 diagrams you will ever need are included.

WITH ALIGNMENT DATA.

Clearly printed circuits, alignment data, parts lists, service hints are the facts you need to speed up all radio servicing. Repair radios quickly and properly—follow the factory instructions given in these manuals. 351 models of 40 largest manufacturers. 192 fact. Packed pages. Large size, 8 1/4 x 11 in. Manual style binding. Well printed. Price postpaid, only **\$2.00**

NEW, POPULAR, LOW-PRICED MANUALS

1941

These easy-to-apply, inexpensive manuals will help you repair radios faster. This volume covers 1941 models, with alignment data, I.F. peaks, and replacement parts lists. Compiled by M. N. Beitman, radio serviceman for many years, author, and teacher. Be an expert in radio servicing; simplify your work. 192 pages 8 1/4 x 11 inches. Only **\$2.00**

1940

Let this important manual give you over 80% of all 1940 circuits you will ever need, acquaint you with new developments, train you to service quickly and efficiently millions of sets. Data on F.M., portables, recording, etc. 417 models of 43 manufacturers. 208 pages. Net price. **\$2.00**



1939

Another handy manual of the most popular diagrams you need. Circuit data, hints and information are time-savers and money-makers for you. Let these diagram manuals guide you to easier service work. Why try to get along without helpful diagrams? Use this volume with 192 pages of diagrams of 39 makes. Only **\$2.00**

Most Popular Models Made by:

Philco, RCA, Zenith, Sears, GE, Emerson, Belmont, Detrola Radio, Fada, United Motors, Westinghouse, Arvin, Majestic, Stewart-Warner, Admiral, De l e c o, Stromberg-Carlson, Western Auto, Sparton, Motorola, Wards, Gamble, and many others.

Other Practical Radio Manuals

RADIO SERVICING COURSE



Let this 22-lesson course help you fix and adjust any radio set. Easy-to-understand explanations; hundreds of simplified diagrams, pictures, practical hints. Quickly learn how to make needed tests, locate faults, complete the repair. Learn new speed-tricks of radio fault finding, case histories of common troubles, servicing short cuts, extra profit ideas. Many active servicemen used this reduced price radio training for brush-up and study of new service methods. Large size: 8 1/4 x 11 inches, 22 lessons, 224 pages. Hundreds of diagrams, illustrations, charts. Price only **\$2.50**

★ STEWART-WARNER MANUAL 50c

★ ARVIN DIAGRAM MANUAL 50c

★ GENERAL-ELECTRIC MANUAL 50c
64 pages of popular circuits. Size: 5 1/2 x 8 1/2 inches

PRACTICAL RADIO MATHEMATICS



Introduces and explains the use of arithmetic and elementary algebra in connection with units, color code, meter scales, Ohm's Law, alternating currents, ohmmeter testing, wattage rating, circuits series and parallel connections, capacity, inductance, mixed circuits, vacuum tubes, curves, the decibel, etc., etc., and has numerous examples. Net **25c**

See Your Radio Jobber or Send Coupon

Supreme Publications

PUBLISHERS OF RADIO BOOKS, MANUALS, AND DIAGRAMS

1926-1938

The most popular volume of the series. Will pay for itself with the time saved during the first day of use. Includes all the popular old timers. Save hours on every job. 427 diagrams of the most serviced radios of this period, with parts lists and alignment information. 240 pages, 8 1/4 x 11 inches. Sold with a money back guarantee. Price, postpaid, **\$2.50**



Compiled by M. N. Beitman, radio engineer, teacher, author & serviceman.

SAVE HOURS ON EVERY JOB

Be ready to make repairs in minutes instead of hours. You will be called upon to fix hundreds of models listed in these easy-to-use manuals. Tackle each job with the needed help found on every page in these handy service manuals. Greatest bargain in diagram books. Send your order today. Use these manuals this week.

NO RISK TRIAL ORDER COUPON

SUPREME PUBLICATIONS, 9 S. Kedzie Ave., Chicago 12, ILL.

Ship the following manuals: (Money back guaranteed)

- 1942 1941 1940 1939 1926-1938
 Radio Servicing Course Stewart-Warner Arvin
 General-Electric Manual Radio Mathematics

I am enclosing \$..... send postpaid.

Send C.O.D. I am enclosing \$..... deposit.

Name:

Address:

(Use Coupon or Send Order in a Letter)



Now YOU

THIS IS TO CERTIFY THAT

Frank's Radio Service
has met the requirements to qualify as

**RAYTHEON
BONDED
ELECTRONIC TECHNICIANS**

A Surety Bond Has Been Issued by the
WESTERN NATIONAL INDEMNITY COMPANY,

Expiring the _____ day of _____ 19__ - Bonding This Firm to:

1. GUARANTEE ITS RADIO REPAIR WORK FOR 90 DAYS FROM DATE PERFORMED and REPLACEMENT PARTS FOR 90 DAYS FROM DATE INSTALLED.
2. Use only parts of recognized quality in its repair work.
3. Not charge more than list prices for parts installed.
4. Test customers' tubes as accurately and reliably as possible.
5. Keep charges for labor at a fair and reasonable level.
6. Perform only such work as is authorized.
7. Maintain the high quality service indicated by the experience required of all Bonded Electronic Technicians.
8. Maintain and use test equipment essential to good repair work and reliable tube checking.



Signed and Sealed

By A. E. Anderson
RAYTHEON MANUFACTURING COMPANY
A. E. Anderson, District Sales Manager

By [Signature]
WESTERN NATIONAL INDEMNITY COMPANY
A. E. Anderson, District Sales Manager

San Francisco and New York - 172 West Van Ness Street, San Francisco, California

can become a

BONDED ELECTRONIC TECHNICIAN

If you can qualify for this new, revolutionary Raytheon merchandising program, you can be sure of greater sales and profits than ever before . . . and you can forget your worries about "security" in the peacetime years ahead.

This program is the perfect answer to those who have been suggesting licensing, government regulation and other impractical "remedies" to protect the public from unethical radio service dealers.

The bond certificate illustrated, showing the code of ethics and 90 day guarantee, and backed by one of the nation's largest surety firms, will be issued to *each* service dealer who can meet the necessary qualifications.

It is only one unit in a *complete* plan which includes the largest, most effective selection of displays and helps ever offered to the radio tube industry.

As a Bonded Electronic Technician, you will **STAND OUT** in your community as the **TOP** radio service dealer . . . the one to be trusted with all kinds of radio service, the one in whom the public can have complete confidence.

So for more service business, increased sales of tubes and other parts, apply to your Raytheon distributor to become a Bonded Electronic Technician. Remember, for your protection Raytheon tubes are distributed only by leading parts wholesalers.

Raytheon
Manufacturing Company
RADIO RECEIVING TUBE DIVISION

NEWTON, MASS. • LOS ANGELES • NEW YORK • CHICAGO • ATLANTA

RAYTHEON
Radio Tubes



DEVOTED TO RESEARCH AND THE MANUFACTURE OF TUBES FOR THE NEW ERA OF ELECTRONICS

AUDELS REFRIGERATION & AIR CONDITIONING GUIDE \$4

New from Cover to Cover—1280 Pages, Fully Illus. Covering basic principles, servicing, operation & repair of household, commercial & industrial refrigeration & air conditioning. A gold mine of essential important facts for engineers, servicemen, shopmen & users.

AUDELS SHEETMETAL PATTERN LAYOUTS..... \$4

Developed by Experts for Sheet Metal Workers, Layout Men & Mechanics. A Practical Encyclopedia in 10 Sections, size 7 x 10 x 2—1125 Pages—350 Layouts—1800 Illustrations. 1001 Key Facts. Fully indexed for ready reference in answering your layout problems. Covers all phases of sheet metal work including Pattern Cutting, Pattern Development & Shop Procedure.

AUDELS SHEETMETAL WORKERS HANDY BOOK..... \$1

Practical inside information. Fundamentals of Sheet Metal Work. 388 pages. Fully illustrated. 11 sections. Clearly written. Essential & important facts, figures, pointers in everyday language. Ready Reference Index.

AUDELS WELDERS GUIDE..... \$1

A concise, practical text on operation and maintenance of all welding machines for all mechanics. Over 400 pages, fully illustrated. Covers all methods of electric and acetylene welding including airplane work.

AUDELS ANSWERS ON BLUE PRINT READING..... \$2

For Mechanics & Builders. Covers all types of blue print reading including ship & airplane. 378 pages, fully illustrated. New, complete.

AUDELS NEW MACHINIST & TOOLMAKERS HANDY BOOK..... \$4

Covers modern machine shop practice in all its branches. 5 practical books in 1. New from cover to cover. Tells how to set up & operate lathes, screw and milling machines, shapers, drill presses and all other machine tools. 1800 pages, fully illustrated, 5 x 8 1/2 x 2. Indexed. 5 sections. 1—Modern Machine Shop Practice. 2—Blue Print Reading & How to Draw. 3—Calculations & Mathematics for Machinists. 4—Shop Physics. 5—How to Use the Slide Rule. 60 chapters. Easy to read and understand. A shop companion that answers your questions.

AUDELS MATHEMATICS & CALCULATIONS FOR MECHANICS. \$2

Mathematics for home study or reference. 700 pages, 550 illustrations. Practical mathematics from beginning. How to figure correctly. New, easy, correct methods covering a complete review. Illustrated & indexed.

AUDELS AUTOMOBILE GUIDE..... \$4

A practical quick ready reference book for auto mechanics, service men, operators & owners. Explains theory, construction and servicing of modern motor cars, 8-cylinder and auto type Diesel engines. 1540 pages, fully illustrated, 58 chapters. Indexed. A standard book for mechanics.

AUDELS DIESEL ENGINE MANUAL..... \$2

A practical, concise treatise with questions and answers on the theory, operation and maintenance of modern diesel engines including General Motors 2 cycle Diesel. 884 pages, fully illustrated, flexible binding. Pocket size. All details plainly brought out, this book is of extreme value to engineers, operators & students.

AUDELS SHIPFITTERS HANDY BOOK. \$1

388 pages of information, instruction, pictures & reference charts, together with many short cuts & trouble savers for shipfitters in their work.

AUDELS RADIOMANS GUIDE..... \$4

A key to the practical understanding of radio including Frequency Modulation, Television, etc., Aircraft & Marine Radio. For radio engineers, servicemen, amateurs. 772 pages. 400 illustrations & diagrams. Photos. Review Questions & Answers, Reference Index. Authentic, clear, concise.

AUDELS MECHANICAL DICTIONARY \$4

960 pages. Over 17,000 new and standard mechanical terms, words, phrases, tables, formulas, helps, hints, short-cuts and practical suggestions. The right word when needed most.

AUDELS HANDY BOOK OF PRACTICAL ELECTRICITY..... \$4

For maintenance engineers, electricians & all electrical workers. 1440 pages, 2600 illustrations. Important electrical information in handy form—including Marine Wiring, Radio Principles, Welding. Fully indexed. The key to a practical understanding of electricity.

AUDELS CARPENTERS & BUILDERS GUIDES—4 Vols. \$6

A practical illustrated trade assistant on modern construction for carpenters, joiners, builders, mechanics and all woodworkers. 4 vols. 1600 pages, 3700 illustrations. Flexible covers. Each volume pocket size. Sold separately \$1.50 a vol.

AUDELS PLUMBERS & STEAMFITTERS GUIDES—4 Vols. \$6

A Practical Trade Assistant & Ready Reference. Explaining in plain language & by clear illustrations, diagrams, charts, graphs, pictures the principles of modern plumbing practice including Marine Pipe Fitting and Air Conditioning. 4 Vols.—1670 Pages—3642 Diagrams. Each Vol. Pocket Size. Sold Separately \$1.50 a Vol.

AUDELS WIRING DIAGRAMS..... \$1

210 Pages, Illustrated. Gives practical facts on wiring of electrical apparatus. It explains clearly in simple language how to wire apparatus for practically all fields of electricity. Each diagram is complete & self-explanatory. A Highly Endorsed Pocket Companion.

AUDELS ELECTRIC DICTIONARY.... \$2

For Every Worker Who Has To Do With Electricity. Enables you to understand and explain electrical problems. Defines more than 9000 words, terms & phrases in plain, unmistakable language, compiled with accuracy & thoroughness. Alphabetically arranged, reference index.

AUDELS MILLWRIGHTS GUIDE..... \$4

Practical up-to-date information on Plant Installation, Operation and Maintenance. 1200 pages completely illustrated, fully indexed. 1000 facts at your fingertips in 8 convenient sections with ready reference.

GUETHS MECHANICAL DRAWING... \$1

A Concise Drawing Course. 150 pages, 50 plates. A complete instructor & reference work. Gives many helpful hints & suggestions on how to draw.

AUDELS ELECTRONIC DEVICES..... \$2

Tells What You Want to Know About Electric Eye. Easily Understood. Covering photo-electric cells & their applications. Amplifiers, illumination, frequencies, voltage, photocell, tubes, Ohm's Law, wiring diagrams, etc.

AUDEL, PUBLISHERS, 49 W. 23 St., N.Y.



**Information in a Handy Form!
AN AUDEL GUIDE IS A GOOD FRIEND!**

Use the brains and experience of others in these Guides of the Trades. Save time and money with right methods, short cuts, labor-saving ideas—"Learn more to earn more." Use our generous 7-day free examination privilege and our dollar a month payment plan. Become a Master in your Trade, and understand the Trades that tie into yours.

How to obtain these Guides for examination. Mark X on the order blank the Guides desired. Every Audel Guide is complete, up-to-date, easily understood with Questions and Answers, fully illustrated and indexed. They speak for themselves. Send for yours today at our risk and expense. Ask to see them.



Check NOW!

You Can Look Over Any Guide In Your Own Home

Start the Easy Payments If Satisfied

MAIL THIS TODAY

CUT HERE MAIL ORDER

THEO. AUDEL & CO., 49 W. 23 St., New York 10, N.Y.

Please mail me for 7 days' free examination the books marked (X) below. I agree to mail \$1 in 7 days on each book or set ordered, and to further mail \$1 a month on each book or set ordered until I have paid purchase price.

If I am not satisfied with Guides I will return them.

- Audels REFRIGERATION & Air Conditioning Guide . \$4.
- Audels POWER PLANT ENGINEERS GUIDE . 4.
- Audels PUMPS, HYDRAULICS & AIR COMPRESSORS . 4.
- Audels WELDERS GUIDE . 1.
- Audels BLUE PRINT READING . 2.
- Audels SHEET METAL WORKERS Handy Book . 1.
- Audels SHEET METAL PATTERN LAYOUTS . 4.
- Audels AIRCRAFT WORKER . 2.
- Audels MATHEMATICS and CALCULATIONS . 2.
- Audels MACHINISTS & TOOLMAKERS Handy Book . 4.
- Audels MECHANICAL Dictionary . 4.
- Audels AUTOMOBILE GUIDE . 4.
- Audels DIESEL ENGINE MANUAL . 2.
- Audels MARINE ENGINEERS Handy Book . 4.
- Audels SHIPFITTERS Handy Book . 1.
- Gueths MECHANICAL DRAWING COURSE . 1.
- Rogers DRAWING and DESIGN . 2.
- Audels MILLWRIGHTS and Mechanics Guide . 4.
- Audels CARPENTERS and Builders Guides (4 vols.) . 6.
- Audels PLUMBERS and Steamfitters Guides (4 vols.) . 6.
- Audels MASONS and Builders Guides (4 vols.) . 6.
- Master PAINTER and DECORATOR . 2.
- Audels GARDENERS & GROWERS GUIDES (4 vols.) . 6.
- Audels ENGINEERS and Mechanics Guides . 12.
- Audels Answers on Practical ENGINEERING . 1.
- Hawkins Aids to ENGINEERS EXAMINATION . 2.
- Audels ELECTRICIANS EXAMINATIONS . 1.
- Audels WIRING DIAGRAMS . 1.
- Audels Handy Book of PRACTICAL ELECTRICITY . 4.
- Audels ELECTRICAL POWER CALCULATIONS . 2.
- Hawkins ELECTRICAL Guides at \$1 each . 10.
- Audels ELECTRONIC DEVICES . 2.
- Audels ELECTRIC Dictionary . 2.
- Audels RADIOMANS GUIDE . 4.
- Audels NEW ELECTRIC LIBRARY at \$1.50 a Volume . 12.

Name _____

Address _____

Occupation _____

Employed by _____

SERVICE Sans INSTRUMENTS

(Continued from page 248)

ume control and touch the diode plates with your screw driver. A click of about the same volume as from the grid should be heard.

We may expedite matters a little by placing our screw driver on the grid of the 6A8 mixer tube. If no sound here, touch the plate. No sound, touch the grid of the 6K7 I.F. tube and hence to the plate of the 6K7. Suppose we get a sound by touching the grid of the 6K7 but a similar action on the plate of the 6A8 tube yields no response. The trouble will likely be in the input I.F. transformer, T₁. If the primary is open, there will be no voltage on the plate of the 6A8.

A shorted trimmer on either primary or secondary would put the transformer out of action. You will have to use your own ingenuity in order to find whether or not they are shorted, once the trouble is isolated to the transformer. Suppose a noise is heard when the antenna post is touched yet the receiver will not respond to a station signal. Now, what could be the trouble? This condition is likely due to the fact that the local oscillator is not functioning. Check for voltage on the oscillator anode with the tip of your screw driver.

By connecting the antenna to the control grid of the 6A8 the receiver should play to some small degree if the primary of antenna coil is open.

The author recalls one case that may bring out the fact that the ordinary type of test instruments, such as multimeters, do not always lend themselves readily to the solution of tough service problems. A very noisy receiver was brought in for repairs. The antenna and ground terminals were tied together to help determine if the noise was originating within the set or being picked up from the outside. It was found to be coming from within the set. Upon switching from the broadcast band to the 25-meter band the noise disappeared. This indicated bad broadcast coils. A little theorizing isolated the oscillator coil for the broadcast band as being at fault. A visual inspection was made to see if it were arcing but with no results. The anode of the mixer tube was shorted momentarily to the chassis, upon which the coil opened. It was replaced with good results.

Many other defects can and do occur which, of course, cannot be covered in an article of this length. A few will be mentioned.

1. Rubbing condenser plates on tuning assembly.
2. Noisy volume and tone control.
3. Oscillations due to open filter condensers, by-pass condensers, loose shields, grid wire near plate lead in R.F. stages, floating metal tube shield (tube housing), etc.
4. Hum due to open or partial open filter condensers.
5. Motor boating (audio oscillation) due to open filter condensers.
6. Failure of A.C.-D.C. sets to light up because of opening tube filament or an open panel lamp.

The author has used a simple receiver for sake of illustration. The same line of reasoning, along with a sound knowledge of radio theory, may be applied to any receiver. Many defects require the use of test instruments to repair; this is especially true where the intermediate frequency alignment has been molested.

RADIO PARTS ELECTRONIC EQUIPMENT



Mail Coupon NOW for
CONCORD
Victory Clearance
Flyer . . . FREE!

● Ready now! 32 Bargain-packed pages listing thousands of standard-make, top-quality radio parts and electronic supplies—now available without priority at low VICTORY CLEARANCE prices. The values listed at the left are typical of the important savings offered in Meters, Condensers, Transformers, Resistors, Controls, Switches, Relays, Test Equipment, Generators, Microphones, Tools, and hundreds of Repair, Replacement, and Accessory Parts. On special requirements, Concord experts are ready to help you in expediting and speeding action on essential needs.

Order Today for Shipment
Tomorrow from
CHICAGO OR ATLANTA

Hugo stocks in TWO convenient warehouses—one in CHICAGO and one in ATLANTA—are ready to supply you quickly with needed parts of dependable, nationally-known quality—and at VICTORY CLEARANCE prices that mean real savings. Mail the coupon below NOW for your FREE copy of CONCORD'S VICTORY CLEARANCE Flyer.

Check These Typical CONCORD VALUES



D. C. Milliammeters
2 1/2" flange mtg. type.
Metal case dull black
finish. G. E. 0-200
M. A. C10650.
Specially
Priced \$4.95



Plate Power Transformer
Pri. tapped at 115,
117 and 120 V.A.C.
Sec. output 850 V. at
200 ma. c. t. 4 1/2" L
x 3 1/2" W x 3 1/2" H.
5B5035.
Your cost \$4.29

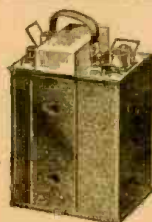

Mobile High Voltage Power Unit
Input 12 V. at 10
amps. Output consists of two voltage
ranges: (1) 275 at 110
ma. (2) 500 at 50 ma.
5B9518
Your cost \$39.50

Output Transformer

Hermetically sealed. Six studs. 1, 2, and 3 are pri. 4, 5, and 6 the sec. Pri. ind. at 5 V. 1000 cy.; .20 H. Ratio sec. to pri. 3.02:1. size: 3 1/4 x 2 41/64" 5B5045.
Your cost \$1.95



Dry Electrolytic Condenser

Hermetically sealed. Size, 1 1/2" x 3" Can negative. Cap.: 40 mfd. at 475 volts; 15 mfd. at 350 volts; 15 mfd. at 150 volts; 20 mfd. at 25 volts. 5B3161
Each 59c



CONCORD RADIO Corp.

LAFAYETTE RADIO CORPORATION

CHICAGO 7, ILL.
901 W. Jackson Blvd.

ATLANTA 3, GA.
265 Peachtree Street



300 Watt Rheostat
Wire wound. Vitreous enameled. Cast aluminum base. 6" dia. 2 1/2" deep. 1400 ohms. 5B9517
Your cost \$3.95

CONCORD RADIO CORPORATION
901 W. Jackson Blvd.
Dept. RC-16
Chicago 7, Ill.



Please RUSH FREE copy of CONCORD'S new 32-page VICTORY CLEARANCE Flyer.

Name
Address
City State

New Radio-Electronic Devices

RADIO MAST

Plymold Corporation
Lawrence, Mass.

THE "Ham-Mast" is designed for U.H.F. and V.H.F., and with slight modification can be adapted for FM and television reception.

This new mast is speedily erected. Two men can erect it



under favorable conditions in 15 minutes. It is suited and adapted to all weather conditions and will withstand wind velocities of 100 miles per hour; is compact, strong and light in weight; is demountable, can be raised or lowered and easily moved from one location to another; and has a low maintenance cost for there are no repairs or painting to worry about. Because the mast is non-metallic, being constructed of wood (exterior grades of plywood), one need not worry about outside interferences in so far as its operation is concerned.

The mast is made up of four sections which telescope and nest into one bundle 14' 3" long. With each mast, two sets of guy wires, a base plate with four base spikes and four anchors are supplied.—Radio-Craft

CRYSTAL UNIT

Bliley Electric Co.
Erie, Penna.

THIS new unit, type ART, is a ruggedly built, temperature controlled crystal assembly designed for such services as police and radio communications where frequency stability must

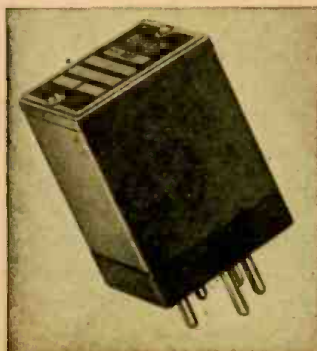

be maintained for temperatures ranging from minus 55°C to plus 75°C. A built-in heater operating on 6.3 volts at 1 ampere provides temperature control within ± 20 C. This permits an over-all frequency tolerance of ± 0.005 % or better including variations due to temperature change as well as tolerances required for crystal production. Type ART Bliley crystal unit is available for any frequency between 3500kc and 11,000kc.—Radio-Craft

TRANSFORMERS

Utah Radio Products
Chicago, Illinois

IN addition to adding many new models to their post-war line, particularly in the jobber and industrial fields, Utah has now established a special transformer division to manufacture special type transformers for specific applications. Included will be hermetically sealed



types as well as the new hypersil transformers developed during the war.

The number of types of transformers available from stock will now be more than doubled that before the war.—Radio-Craft

AUTO DOT-DASH BUG

Melehan Radio
Huntington Beach, Calif.

THE Melehan Valiant automatic telegraph key, which makes both dots and dashes automatically, derives its initial impulse of operation solely by means of the force imparted to it by the operator, in much the same manner as that which actuates the vibratory or oscillating unit of the bug. In the automatic, a pair of vibration units are employed, which, because of their individual and unique design and disposition, (the dash unit having a substantially longer vibrating spring and contact spring) cause to be transmitted either a series of dots or a series of dashes, or any combination of the two. Each is capable of being individually adjusted, in speed, (rate of oscillation), amplitude of vibration, (amount of swing), "weight" of the dots

or dashes (length of time actual contact is maintained during each cycle of vibration), and adjustment spring tension (force applied by the adjustable spiral spring utilized to return the vibrating arms and

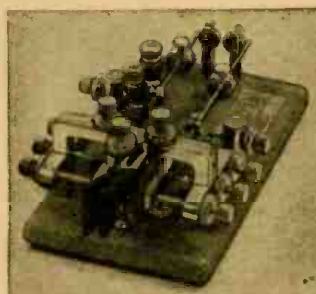

the handle unit to normal, inoperative position).

Primarily designed for high speed code transmission at speeds in excess of 50 wpm, the Valiant is capable of full coverage over a complete range of 15 to 75 wpm with full retention of smooth and instantaneous response characteristics over this wide range.—Radio-Craft

FM BROADCASTERS

Federal Telephone and Radio Corp.
Newark, New Jersey

THE new transmitters are of the highly practical multi-unit design, permitting the broadcasting station to increase its output when desirable.

The basic unit of Federal's new FM broadcast transmitters is the exciter which generates the initial radio frequency power, in itself, a complete 250-watt transmitter. In this unit are included the frequency modulation system, center frequency stabilization system, and the radio frequency multiplier and output stages. The 250-watt output of the exciter unit is stepped up to 1, 3, 10, or 50 kilowatts by a power amplifier unit or series of such units.

The new FM broadcast antenna arrays are fed by standard coaxial lines, combining high power gains with non-critical tuning, and consists of from 1 to 12 or more loops, each embodying two or more half-wave elements. The arrays are factory-tuned for easy installation.—Radio-Craft

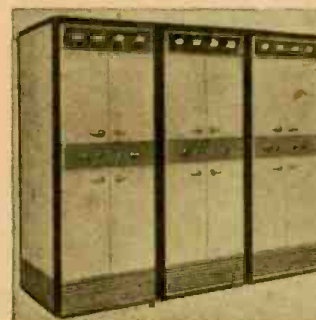

ANTENNA AMMETER

The Andrew Co.
Chicago, Illinois

OPERATING on a new principle without the usual thermocouples, this new electronic remote antenna ammeter employs a remotely-located D.C. microammeter, actuated by a current transformer feeding a diode-rectifier tube located at the antenna.

Since the regular thermocouple antenna ammeters can be disconnected most of the time, the station using this new unit is spared the frequent cost of meter replacement. Likewise,



station shutdowns due to thermocouple failure in lightning storms are eliminated.—Radio-Craft

RECTIFIER UNITS

Radio Receptor Co.
New York, N. Y.

THE appeal of these units has been increased by utilizing aluminum in place of iron or similar metals, and by developing a method of sealing the unit hermetically, thereby assuring maximum performance under all climatic conditions, ranging from the Arctic to the Tropics.

The use of aluminum reduces the unit weight by two-thirds and at the same time enables



vastly more efficient heat dissipation and provides for an increased margin of protection beyond normal plate rating.

This new line embraces a wide range of units—from 25 mjs up to capacities of hundreds of amperes—thus offering an efficient unit for every industrial application, for all combinations of voltage and current outputs and for various types of circuits.—Radio-Craft

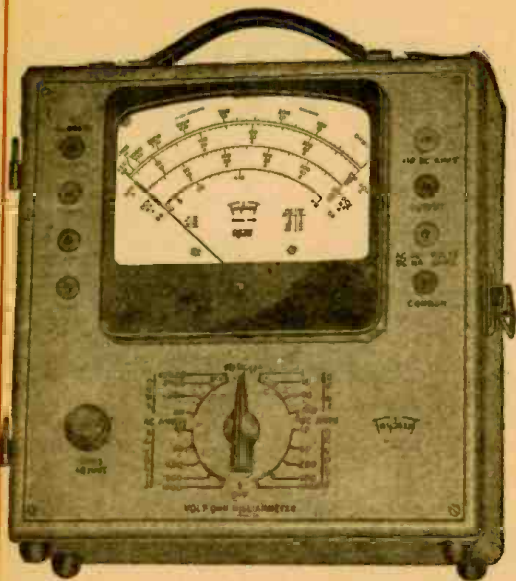

MODEL 2406

Volt-Ohm-Milliammeter

25,000 OHMS PER VOLT D.C.



SPECIFICATIONS

NEW "SQUARE LINE" metal case, attractive tan "hammered" baked-on enamel, brown trim.

- PLUG-IN RECTIFIER—replacement in case of overloading is as simple as changing radio tube.
- READABILITY—the most readable of all Volt-Ohm-Milliammeter scales—5.6 inches long at top arc.
- RED-DOT LIFETIME GUARANTEE on 6" instrument protects against defects in workmanship and material.

NEW ENGINEERING • NEW DESIGN • NEW RANGES 30 RANGES

- Voltage: 5 D.C. 0-10-50-250-500-1000 at 25000 ohms per volt.
 5 A.C. 0-10-50-250-500-1000 at 1000 ohms per volt.
- Current: 4 A.C. 0-.5-1-5-10 amp.
 6 D.C. 0-50 microamperes — 0-1-10-50-250 milliamperes—0-10 amperes.
- 4 Resistance 0-4000-40,000 ohms—4-40 megohms.
 6 Decibel -10 to +15, +29, +43, +49, +55
 Output Condenser in series with A.C. volt ranges.

Model 2400 is similar but has D.C. volts Ranges at 5000 ohms per volt.

Write for complete description

Triplet

ELECTRICAL INSTRUMENT CO.

BLUFFTON, OHIO.

A.S.C. RADIO

(Continued from page 241)

(audio-frequency), which are variable- μ tubes. Negative bias on tube AF_2 is markedly greater than on AF_1 .

The two diodes (of course, it is possible to make use of a single double-diode with separate cathodes, such as 6H6) are connected in opposition. Thus, when signal intensity increases, the grid of AF_1 becomes more negative while that of AF_2 , on the contrary, becomes less negative. As a consequence, for all strong signals, AF_2 amplifies more than AF_1 .

With a weak signal, the gain of AF_1 becomes greater than that of AF_2 , because the latter, being strongly biased, works with a very low μ .

Now, the voltages applied to tube AF_1 belong to the high selectivity path, since detection is effected after the output of TR (secondary). Moreover, the output voltage of AF_1 is applied to a loud-speaker and amplifier, both of which favor the low and medium registers.

Tube AF_2 is a part of the low-selectivity

path since the voltages applied to detector D_2 have not been subjected to the selective action of the secondary of TR. Moreover, the output of AF_2 is coupled with an A.F. amplifier and a loud-speaker which both favor the higher notes.

Summing up, it will be appreciated that, where weak signals are concerned, amplification is mainly provided by the more selective of the two paths while, for stronger signals, most of the gain is provided by the lower selectivity path.

It should also be noted that, while the D.C. components of the detected voltages are wholly applied to the grids of the A.F. pre-amplifiers, their A.F. components are processed in a different way. The latter can be regulated by manual adjustment of potentiometers P_1 and P_2 , which can be either independent or connected in such a way as to be operated by one and the same knob. In the second case, they are operated so as to remain in opposition, an increase of voltage in one potentiometer causing a decrease in the other.

In conclusion, let us draw attention to the great elasticity provided by the recommended methods, which lend themselves to a number of possible variations which the reader can imagine without difficulty.

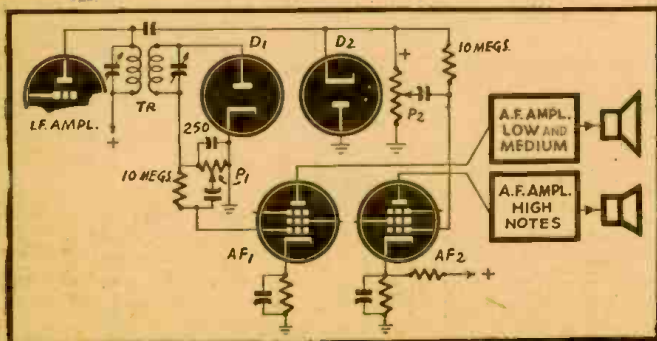
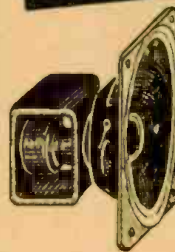

Fig. 4—Diode-biased audio stages control the selectivity here.

SOUND VALUES at TERMINAL RADIO



Special!
2" Permanent Magnet Speaker

Ideal for small radios and intercommunicating systems. Can also be effectively used as a dynamic microphone.

Well built, compact and very efficient. Voice coil impedance — 4 ohms. Shipping weight 2 lbs. If ordering by mail, add 15c for postage. **SPECIAL ... 98c**

HAMS! P.A. MEN!

Heavy Duty
Black Crackle
Steel Cabinet

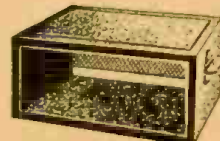

For desk housing small transmitters and amplifiers. Size 19" x 12" x 10". For 8 3/4" x 19" panel. Recessed handles on each side, ventilated rear section. Hinged top door complete with snap lock. Shipping weight 20 lbs.

Special\$3.98
 Steel panel (8 3/4" x 19")88
 Steel chassis (11" x 17" x 2") 1.35

TERMINAL Radio Corp.
 85 CORTLANDT STREET • NEW YORK 7, N. Y.
 Phone: WOrth 2-4415

TRY THIS ONE!

XTAL ADJUSTER

The crystal enthusiast and experimenter is constantly changing and trying new circuits and substituting components and coils of various sizes and types. In making these changes it is necessary to adjust and reset crystal detectors. Often a true comparison of the changes and substitutions cannot be made. By

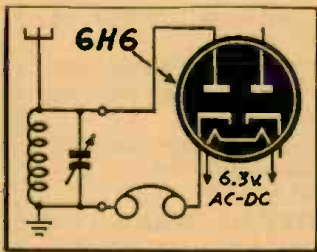

using one side of a 6H6 tube and heating it with either a 6-volt battery or a 6-volt transformer you have a perfect and stable detector. No other voltages are necessary. It works the same with the cathode or plate hooked either way in the circuit. For easy handling place the tube in an unmounted octal socket and solder leads to one plate and one cathode pin (either to pins 3 and 4, or to pins 5 and 8). Using Fahnstock clips this detector can be slipped in and out of the circuit very easily.

This is a little louder than the average crystal, but good crystals will equal its volume. This also gives a good check on the various crystals being experimented with. The compact size of this tube and socket make it less bulky than some crystal holders and detectors.

The real crystal fan, however, operates without tubes and batteries and will therefore replace this 6H6 detector with his crystal after he has made his adjustments.

J. B. TANNEHILL,
Salem, Illinois.

SPEAKER GRILLE

A convenient and modern-looking grille for small speakers can be made from a plastic screen or old dial celluloid. The dial covering is well adapted for this purpose as it is convex rather than flat. It can be glued in place from the inside of the cabinet. If thin celluloid is used, slots can be cut with a penknife or single-edged razor blade following any design which may appeal to the constructor's taste.



The grille can be given a coat of shellac or paint if desired as a finish or can be left in its

Radio-Craft wants original kinks from its readers, and will award a seven-month subscription for each one published. To be accepted, ideas must be new and useful. Send your pet short-cut or new idea in today!

transparent state, thus giving a clear view of the speaker cone at all times.

TOM LAMB,
Mansfield, Ohio.

PHONE CONTROL

The diagram serves to show the limitations of, and suggested improvements to, a type of tone control similar to that described by A. C. Shaney in the June 1940 issue of *Radio-Craft*. This circuit provides independent accentuation and attenuation of both the high and the low frequencies.

However, because of the dual

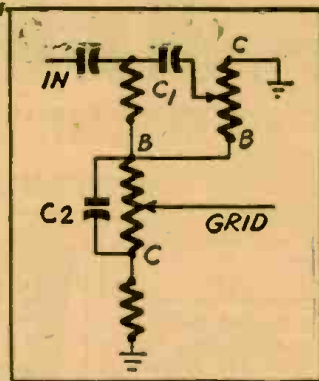

function of each control—that is, boost and cut—the associated condensers C_1 and C_2 have compromise values. When C_1 is made large enough to provide proper attenuation of the high frequencies in the cut position, the amount of accentuation in the boost position becomes ex-

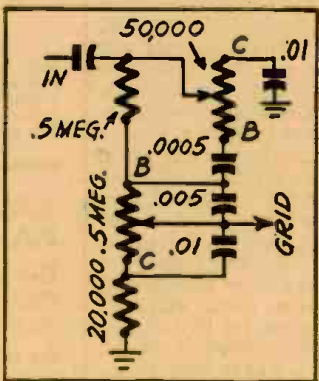

cessive. This same difficulty applies to the bass control. When C_2 is made small enough to provide proper attenuation in the cut position, the accentuation in the boost position is excessive. Another objection to this circuit is that for any mid-setting of the bass control, the high frequencies are attenuated due to

the resistance added in series with the grid.

The second circuit is designed to overcome these objections and to provide for much greater flexibility. The component values may be varied to provide any desired degree of compensation. The values shown are merely suggested ones and need not be copied exactly. Perhaps a little experimentation might be necessary before the ideal set of conditions is obtained.

ARTHUR SHOGREN,
Operator, Radio WAY,
Chicago, Ill.

PHONE TIPS

Headphone cords and cords on test equipment have a bad habit of breaking off right at the shoulder, and usually do so just when you need them most. I solved the problem of eliminating that weak point simply by soldering another tip on the end of the existing tip. This removes the strain from the weak cord and places it on the strong phone tip. Formerly the cords on my test equipment broke every few months. Since using this double-tip idea, I have had the same cord set in constant use for nearly two years and not a break has occurred yet.

JOSEPH AMAROSE,
Richmond, Va.

HUM REDUCER

Here is a kink for reducing hum which originates in the power transformer.

In case 1, the negative return of the B circuit is made to pass through the core or shell of the power transformer, where it forms a field which neutralizes the hum caused by the regular field.

The exact action is difficult to analyze, and it cannot be

claimed that the idea will produce satisfactory results under all conditions; but nevertheless satisfactory results have been obtained by this method.

Case 2 shows another variation which has been found to work well under certain conditions.

The positions of contact with the shell of the transformer, marked A and B, must be varied by experiment until best results are obtained.

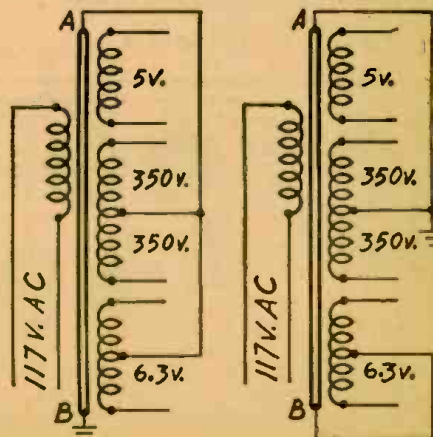

It should be noted that the power transformer must be insulated from the metal chassis.

RALPH W. MARTIN,
Los Angeles 32, Calif.

XTAL REPAIR

I am stationed in one of the island bases in the Pacific and am particularly fortunate in having a phonograph to brighten up the dull hours of barracks life. However, the speaker ceased emitting the comforting tones of Crosby one day and, after a careful inspection of the unit, this is what I found.

The tinfoil covering of the crystal was almost completely gone due to corrosion and the negative foil strip was broken. The inner foil strip was still intact and in good shape. Since there wasn't a replacement on the island, I struck upon this idea, with good results.

First, remove all the lead foil outer covering and wipe the crystal clean using carbon tetrachloride (Carbona) or alcohol. Be careful not to damage the interelement lead. Now procure about 15 feet of No. 30 bare copper wire and, starting at the front of the crystal, close-wind the entire crystal tightly. When you get down to the end, twist the two ends of the wire together and solder them to the lug. Carefully replace the crystal in the case, taking care to keep the rubber mounts in place.

JOHN E. STOUT,
Aviation Radioman 1/c
San Francisco, Calif.

STAND-BY SWITCH

On our signal generators in the lab we installed a stand-by switch in the B-plus circuit so that the signal could be cut off when not wanted, yet was ready to use in an instant without warming up. This prevented an interfering signal from being picked up when we did not want one. Simply placing a toggle switch in the B-plus circuit does the trick.

KENNETH C. DIKE,
Seattle, Wash.

Portable Phono-Radio

By JOHN F. MILLAR

An old portable phonograph can be converted into a phono-radio combination with a little careful planning and circuit design. We discovered this on modernizing an ancient model which had taken up attic space for several years.

The phonograph—an old Victor—was contained in a very presentable carrying case and we decided to construct a small amplifier inside the case to make an up-to-date portable.

The first step was the removal of the spring motor and substitution of an inexpensive rim-drive phono motor. Then the mechanical reproducer was discarded and replaced by a crystal pickup. The next problem was to design an efficient amplifier small enough to fit the limited space and still leave room for a speaker. The minimum requirement appeared to be a two stage unit with a transformerless power supply and on consulting the tube manual we decided the most suitable lineup of available tubes to be a 12J5GT driving a 50L6GT, with a 50Y6GT rectifier.

Our first thought was to use a simple half wave rectifier circuit for power supply, but on considering the current requirement—approximately 65 mls—and the unavoidable voltage drop of a small filter choke, we found the voltage output would be too low. The answer here was obviously a voltage-doubling circuit, but now the voltage would be far in excess of the rating on a 50L6GT. Eventually we made a compromise which involved a full wave voltage doubler and the 1400-ohm field coil of a 6-inch speaker. This solved the filter choke problem and at the same time served as a dropping resistor to reduce the plate voltage of the 50L6GT to 135 under operating conditions. While this exceeds the nominal rating of this tube (117 maximum plate volts) by about 15% it is not an extreme overload and increases the power output to a worthwhile extent.

The remainder of the amplifier circuit is conventional, though the following points may be of interest: The combination of a 0.1 mfd. condenser and a 2600-ohm resistor across the output acts as a corrective filter to improve the frequency characteristic of the output stage, while the large cathode bypass condensers assure good low frequency response. The .004 mfd. condenser CB from first amplifier plate to ground was found necessary to prevent oscillation, although this was undoubtedly due to the crowding of the layout (as the amplifier

HAM HEADQUARTERS FOR

Equipment and Information

15 YEARS of Service

to HAMS throughout the U.S. and Canada.

Complete Line

of nationally famous Radio and Electronic Parts and Equipment.

Thousands of Items

in stock right now comprising every well known brand of Component Parts and Equipment.



Get Started on Your
"DREAM SET" TODAY!

We have all the component parts and equipment and our HAM department, which is staffed by Engineers, will gladly help you with your problems. Write, 'phone, or visit us today.

FREE Write today for our current bulletins about extraordinary values in surplus Radio and Electronic Component Parts and Equipment.

Radio Product Sales Company

238 WEST 15TH STREET
LOS ANGELES 15, CALIFORNIA Prospect 7471

and power supply are built on a sheet metal chassis only 7 x 3 x 1½ inches).

The results obtained thus far were highly satisfactory, as our amplifier had excellent tone and plenty of gain for the average crystal pickup. Some months later we considered the possibility of adding a tuner to make a complete portable combination. For best possible efficiency a superhet seemed in order and again the tube manual was put to work. The most suitable tubes were a 7A8 and a 12C8 for the circuit we had in mind, which was a converter followed by a combined I.F., detector and A.V.C. stage. We used Meissner adjustable antenna and oscillator coils for easy tracking adjustment and iron core I.F. transformers for high gain. The final circuit is straightforward though some details call for discussion.

The use of separate diodes for detector and A.V.C. has several advantages, the

most important being to reduce the loading on the secondary of the output I.F. transformer. This is accomplished by coupling the A.V.C. diode to the plate circuit of the I.F. stage. Another advantage is the reduction of the shunting effect of the A.V.C. circuit on audio output as occurs with the use of a single diode for both functions. A third advantage is the delayed A.V.C. obtained due to the A.V.C. diode return being made to ground rather than to the cathode. This places the bias voltage, developed across the cathode resistor R7, on the diode plate. The signal voltage must then exceed this bias value before rectification can occur and A.V.C. voltage be developed; thus maximum amplification is obtained on weak signals.

The tuner was assembled on another small chassis and connected to the amplifier unit as shown in the diagram. The D.P.D.T. (Continued on page 273)

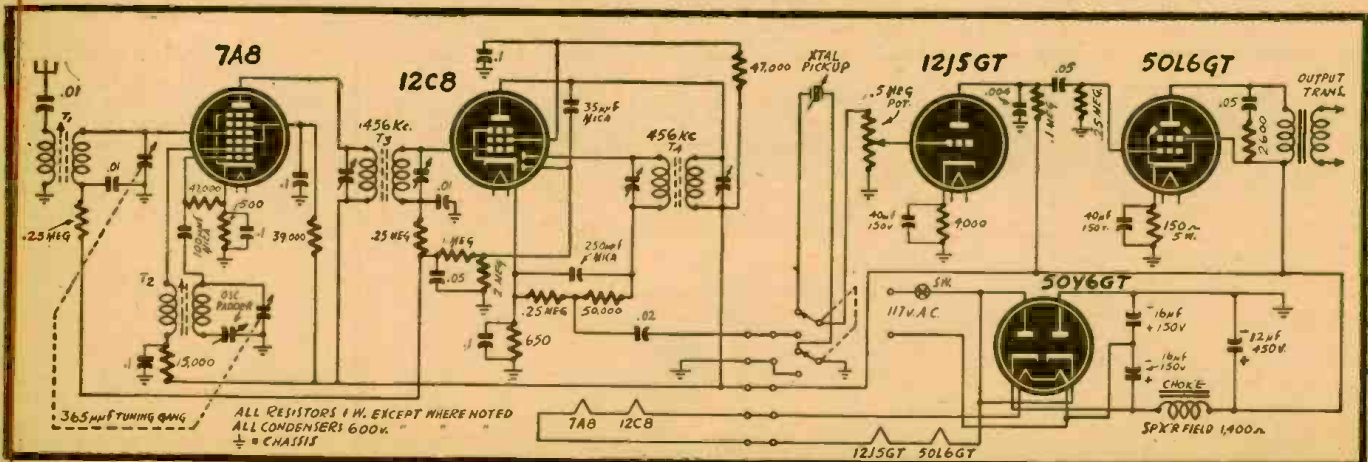

THE QUESTION BOX

4-TUBE RECEIVER

? I have a four-tube set using the following tubes, 12K7, 12F5, 12SF5 and a 35L6, but the reception is very poor. I would like a very efficient four-tube set using 6-volt tubes of the following types, 6SK7, 6C5, 6V6 and a 6X5.—L.L.H., Oklahoma City, Okla.

A. The diagram shows a circuit of a receiver using 6-volt tubes. All parts have been specified. (See Fig. 1)

You will note that a 6J7 tube is shown as a detector. This tube has considerably more gain than the 6C5 but you may omit C1 and C2 and use the 6C5 if you desire. Due to the fact that three different filament currents are required, it is considered best to use a small 6-volt transformer to supply the filaments. A rating of 6.3 volts at 2 amperes is sufficient for the secondary. To omit this transformer and connect the tubes across the line would require shunts across the .3- and .45-ampere filaments and a heavy line-cord resistor in series with all.

CONDENSER TESTER

? Will you please print a diagram of a condenser tester.—W.W.V., Cortez, Colo.

A. The diagram shown (See Fig. 2) is of a condenser tester which can be built from standard parts. The final accuracy of the finished unit will depend on the accuracy standards and care used in calibrating the 400-ohm potentiometer, which should be a wire-wound type. The components inside the dashed-line square should be of the highest accuracy, those outside this area being ordinary circuit components and requiring no more than ordinary tolerances, say 5 to 10 percent.

If it is desired to check capacity only, R₁, R₂, R₃ and R₄ may be omitted. All other parts would be unchanged.

The Question Box is again undertaking to answer a limited number of questions. Queries will be answered by mail and those of general interest will be printed in the magazine. A fee of 50c will be charged for simple questions requiring no schematics. Write for estimates on such questions as require diagrams or research.

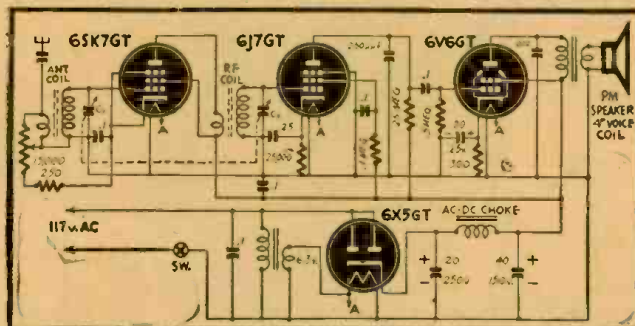

Fig. 1—A simple receiver using one 6-volt filament transformer.

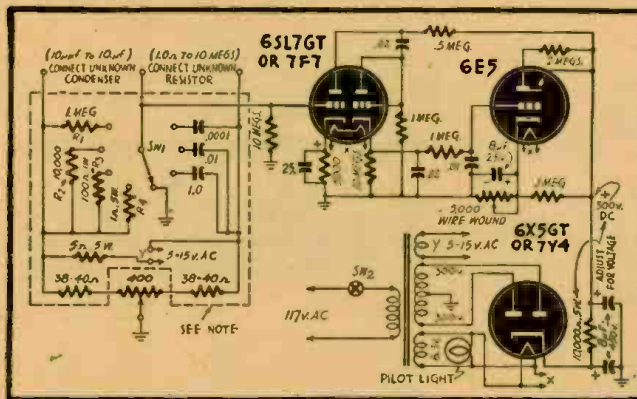

Fig. 2—Three-tube condenser checker using electron-ray indicator.

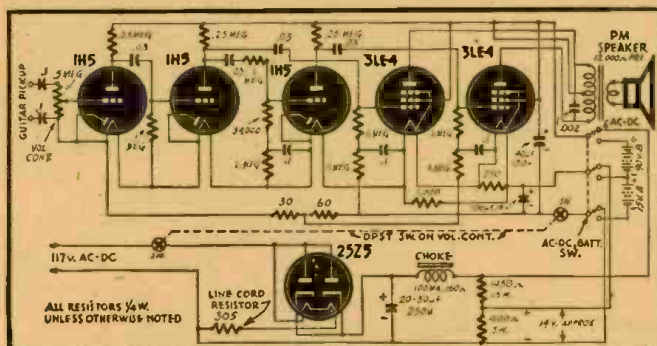

Fig. 3, above—Guitar amplifier. Fig. 4, below—5-tube receiver.

5-TUBE TRF

? Please print a diagram of a 5-tube circuit using some of the following tubes: 37, 25Z5, 43, 6C6, 6D6, 77. I can use either a PM or a dynamic speaker. Please furnish voltage measurements on the diagram.—B. A. W., Charleston, S. C.

A. The diagram shown (See Fig. 4) is of a circuit using five tubes as you have specified. A grid-bias detector is shown. This will handle strong signals. However, a grid leak and condenser detector could be substituted if desired. It would have the advantage of greater sensitivity, but would be subject to distortion with a strong signal.

None other than the usual precautions will need to be observed in construction except that in building A.C.-D.C. types of receivers, the chassis and parts connecting to it, if used as a common ground, must be covered or protected by a cabinet to prevent personal injury from shock when the set is in use.

GUITAR AMPLIFIER

? I would like to know if you can print a diagram of an electric guitar amplifier using 1.5-volt tubes, and a 25Z5 for the power supply and so constructed that it can be used as an A.C.-D.C. job or as a portable battery amplifier, at will. I would like to be able to build one that would deliver about two watts.—Cpl. W.F.S., Pattonsburg, Mo.

A. The diagram (See Fig. 3) shown is for a guitar amplifier drawn up along the lines you specified. Tubes of the 1.4-volt types with higher wattage output are available and could have been used if it would not have been necessary to keep within the limits of the 25Z5. However, the layout as shown will give you about one watt output. This will usually be satisfactory.

3-TUBE REGENERATIVE

? I have available old-type tubes (a 24A and two 27's) which I would like to develop into a radio receiver. No transformers are to be used since none are available here. What is the most sensitive receiver I can build?—F.A.M., Worthington, Ohio.

A. Your best bet is a regenerative stage followed by two of audio. You may use either phones or a magnetic speaker. The regeneration control is a variable condenser in the plate circuit of the 24A. The power supply should have 2.5 volts for the filaments and about 180 volts for the plates.

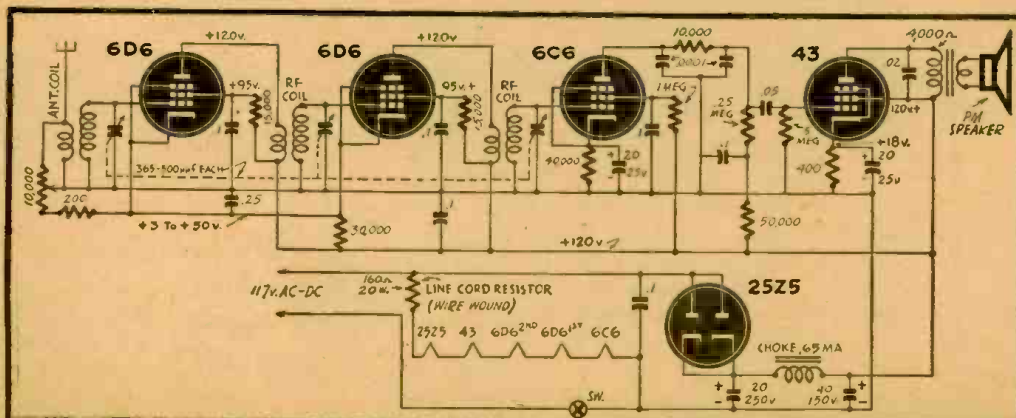

RADIO OPPORTUNITIES

(Continued from page 247)

Pearl Harbor employment by 68 per cent. This would help to pave the way for the willing beginner, provided the desire to "treat each day's work as a lesson to benefit by and remember" is present in the individual.

SCHOOLS AND TRAINING COURSES

Lacking an opportunity to gain knowledge and practical experience "on the job" perhaps the best way a novice can gain his knowledge is through the various courses given at the different radio schools throughout the country. The GI Bill of Rights, otherwise known as the Servicemen's Readjustment Act of 1944, provides for tuition and school expenses up to \$500 a year. The majority of radio institutes and schools come under these provisions, as the average cost of a complete radio and television course should not exceed this amount.

Courses in radio deal not only with the technical processes but also the semi-technical and non-technical angles. Schools for actors, for designers, for prop men, for studio directors, and for many other special positions are open or are opening up regularly. Though it is not necessary to know Ohm's law or the evolution of the Pythagorean theorem in order to become a set designer or camera locator, night studies towards a possible advancement in position (with the burden of added responsibilities) would not be amiss.

THE POST-WAR SERVICEMAN

So much for the beginner. But what about the radio serviceman coming out of service? Will he find such a rosy general picture as has been painted here for the beginner? Or will he come back to his old industry, and find it changed greatly? New advances in the past four years, new methods of doing things, new attitudes, new businesses and business methods—all work together to produce a changed picture. Wartime exigencies have produced a bumper crop of "substitute servicemen" whose only credo is—"If you haven't got it, replace it with another value or cut it out of the circuit." (This has proved a boon to the radioman just starting when the war broke out, for it taught him more about practical radio than he would have learned in years of peacetime work with plenty of parts available.)

The skyrocketing of set prices, OPA notwithstanding, is still continuing and will continue as long as parts, tubes and sets are scarce. This means that the veteran desiring to re-establish himself will have to pay disproportionate prices for his stock and equipment. Second-hand radios which normally sold for \$9.95 when new, and should be retailed as used merchandise at a price of \$4.00 or \$5.00, command the fantastic figure of \$35.00 to \$40.00!

Add to this the increasing competition and you have the major part of the picture. In New York City alone, 365 radio stores are opening yearly, or an average of one a day! These are radio stores alone and do not include those that sell or repair electric appliances or sales outlets for other electronic apparatus. Since a given community can support only a certain number of stores, disaster will shortly overtake those that cannot survive the competition.

What about the fellow who knows nothing else but servicing? He can either fight competition (sometimes successfully) or

(Continued on following page)



Jobbers told us, even before the first "VOMAX" had been shipped, that its unmatched specifications had instantly established it as the standard of comparison among their clients. Its outstanding superiority is its completeness. "VOMAX" makes you master . . . no longer victim . . . by at last giving you the ability to measure directly . . . accurately . . . every operating —and signal—voltage in radio receivers.

Not only does "VOMAX" measure every voltage . . . d.c., a.c., a.f., a.v.c., limiter, discriminator, power output. With it you can at last measure r.f. signal voltages up beyond 100 mcs. in actual receiver operation! Here is true visual dynamic signal tracing.

Read the brief specifications at the right and you'll see why "VOMAX" has been purchased by the military, universities, atomic bomb research laboratories, great industrial organizations and by thousands of wide awake service technicians.

Designed for precision laboratory use, tremendous sales enable us to still keep "VOMAX" price well below OPA ceiling. "VOMAX" measures every voltage directly . . . makes you the master . . . for only \$59.85.

"VOMAX"

Measures EVERY Voltage

1. Brand new post-war design . . . positively not a "warmed-over" pre-war model.
2. More than an "electronic" voltmeter, VOMAX is a true vacuum tube voltmeter in every voltage/resistance/db. function.
3. Complete visual signal tracing from 20 cycles through over 100 megacycles by withdrawable r.f. diode probe.
4. 3 through 1200 volts d.c. full scale in 6 ranges at 51, and in 6 added ranges to 3000 volts at 126 megohms input resistance. Plus-minus polarity reversing switch.
5. 3 through 1200 volts a.c. full scale in 6 ranges at honest effective circuit loading of 6.6 megohms and 8 mmfd.
6. 0.2 through 2000 megohms in six easily read ranges.
7. — 10 through + 50 db. (0 db. = 1 mw. in 600 ohms) in 3 ranges.
8. 1.2 ma through 12 amperes full scale . . . 6 d.c. ranges.
9. Absolutely stable—one zero adjustment sets all ranges. No probe shorting to set a meaningless zero which shifts as soon as probes are separated. Grid current errors completely eliminated.
10. Honest, factual accuracy: $\pm 3\%$ on d.c.; $\pm 5\%$ on a.c.; 20 cycles through 100 megacycles; $\pm 2\%$ of full scale, $\pm 1\%$ of indicated resistance value.
11. Only five color-differentiated scales on 4% D'Arsonval meter for 51 ranges (including d.c. volts polarity reversal) eliminate confusion.
12. Meter 100% protected against overload burnout on volts/ohms/db.
13. Substantial leather carrying handle. Size only 12 $\frac{3}{4}$ " x 7 $\frac{1}{4}$ " x 5 $\frac{3}{4}$ ".

Send postcard for free catalog of measurement and communication equipment.

OVER 34 YEARS OF RADIO ENGINEERING ACHIEVEMENT

McMurdo Silver Company

1240 MAIN STREET, HARTFORD 3, CONNECTICUT

Position Available	Minimum Education	Minimum Experience	Minimum Training
Apprentice Engineer	H.S. plus 6 mos. radio		Six months to one year
Studio Engineer	High School	Two Years as Eng.	One Month
Field Engineer	High School	Two Years as Eng.	Six Months
Maintenance Engineer	High School	Five Years	One to Two Years
Recording Engineer	High School	Six months as Record.	Two Months
Transmitter Engineer	High School	1st Class license	Three to Six Months
Receiver Maintenance	High School	Five Years	None
Construction Man	High School	Mechanical Skill	
Television Technician	H.S. plus 6 mos. radio	None	One Year
Video Camera Eng.	High School	Two years camera exp.	Three Months
Studio Engineer Video	High School	Two Years	Three Months
Studio Engineer Audio	High School	Two Years	Three Months
Maintenance Engineer Television	High School	Five Years	One to Two Years
Projection Engineer	H.S. Radio & Photog.	License Preferred	Six Mos. to One Year
Televis. Receiver Eng.	High School	Four to Five Years	None
Tele. Studio Operator	High School	One Year	One Month
Transmitter Eng. Tele.	High School	One Year	One Month
Sound Effects Technicians	High School plus		
Sr. Sound Effects Technicians	High School	Mechanical Training	One to Two Years
		Two-five Years	Two to Six Months

LET THIS "AUTOMATIC TEACHER" show you exactly how to repair over 4800 RADIO MODELS without expensive test equipment!

SAVE TIME—SAVE MONEY!

Ghirardi's **RADIO TROUBLESHOOTER'S HANDBOOK** is the ideal manual to show you exactly how to repair radios at home in spare time—quickly and without a lot of previous experience or costly test equipment. It contains **MORE THAN 4 POUNDS OF FACTUAL, time-saving, money-making repair data** for repairing all models and makes of radios better, faster and more profitably than you may have thought possible!

NOT A "STUDY" BOOK

RADIO TROUBLESHOOTER'S HANDBOOK can easily pay for itself the first time you use it. You don't have to study it. Simply look up the make, model, and trouble symptom of the Radio you want to repair and go to work. No lost time! Clear instructions tell exactly what the trouble is likely to be—**EXACTLY** how to fix it. Actually, this big 744-page manual-size **HANDBOOK** brings you factual, specific repair data for the common troubles that occur in practically every radio in use today—for over 4800 most popular models of Home and Auto-radio receivers and Automatic Record Changers of 202 manufacturers! In addition, there are hundreds of pages of helpful repair charts, tube charts, data on tuning alignment, transformer troubles, tube and parts substitution, etc., etc.—all for only \$5 (\$5.50 foreign) on an **UNRESERVED 5-DAY MONEY-BACK GUARANTEE!**



Get a Complete RADIO-ELECTRONIC SERVICE EDUCATION AT HOME—WITHOUT AN INSTRUCTOR



TEST INSTRUMENTS—TROUBLESHOOTING REPAIR

A. A. Ghirardi's big 1300-page **MODERN RADIO SERVICING** is the finest, most complete instruction book on Radio-Electronic service work for either the novice or the professional Radio-Electronic serviceman—*bar none!* Read from the beginning, it is a **COMPLETE COURSE IN SERVICING** by the most modern methods. Used for reference, it is an invaluable means of brushing up on any servicing problems that puzzle you.

Gives complete information on all essential service instrument types; how they work (with wiring diagrams), when and why to use them; how to build your own; preliminary parts analysis; parts repair, replacement, substitution; obscure radio troubles; aligning and neutralizing; interference reduction—and hundreds of other subjects including How to Start and Operate a Successful Radio-Electronic Service Business. 706 self-testing review questions help you check your progress **EVERY STEP OF THE WAY**. Only \$5 complete (\$5.50 foreign).

MONEY-SAVING OFFER!

While the present limited supply lasts, you can get **BOTH** big books—radio's most famous complete Modern Service library totaling over 2040 pages—at a bargain combination price. See coupon.

5-DAY MONEY-BACK GUARANTEE

Technical Division, MURRAY HILL BOOKS, Inc.
Dept. RC-16, 232 Madison Ave., New York 16, N. Y.

- Enclosed find \$..... for books checked, or send C.O.D. (in U.S.A. only) for this amount plus postage. If not fully satisfactory, I may return the books at the end of 5 days and receive my money back.
- MODERN RADIO SERVICING** \$5 (\$5.50 foreign) **RADIO TROUBLESHOOTER'S HANDBOOK** \$5 (\$5.50 foreign)
- Special MONEY-SAVING COMBINATION**
Both big books for only \$9.50 (\$10.50 foreign)

Name
(Please print or write plainly)

Address

City and Dist. No. State

"BORROW" THESE BOOKS for 5 full days. Money refunded if you don't like them!

RADIO OPPORTUNITIES

(Continued from previous page)

can learn another trade or another branch of radio. In either case, the picture is not so pretty as might at first be imagined.

It has been stated in the past, and it is still true, that electronics and radio offer unlimited opportunities for everyone, BUT, and it is a big but—it does not offer high-salaried jobs to all comers. For the enterprising and capable man, the radio industry (or any industry for that matter) has a fine position. For the person who is not quite a go-getter and who lacks know-how, spirit and resourcefulness, it is a different matter. It would be better for all concerned if he were to find a job in another field.

The War Production Board has taken this into account in advising veterans and the various banks authorized under the Servicemen's Readjustment Act of 1944 have done the same. A veteran's qualifications are thoroughly examined and weighed in the light of present conditions. If found wanting, he is advised not to attempt to open a business just now, or his loan is turned down.

There have been many cases where the wholesaler or jobber has favored the dealer who didn't go off to war, since it was this dealer's patronage that kept the wholesaler or jobber in business. There is still a trend towards favoring these dealers rather than the newcomer, for various psychological and business reasons.

The radio industry directly has over 200 different types of jobs calling for different grades of skill, and indirectly, over 2000 different types of positions ranging from non-technical to those calling for the skill and knowledge of a scientist. Some of these categories are shown in the table on preceding page. Luck, perseverance, knowledge, skill and willingness to work will make for a success in radio. The struggle to the top is summed up perfectly by Brigadier General David Sarnoff, when he states:

"Thousands of GI's on the way to camp through the Pennsylvania Station in New York have had the doors swing open automatically as they approached—that is electronics at work! But there are no automatic 'swings' on the doors of opportunity—to open them, one must push!"

CORRECTION—CAPACITORS

THE article, "Capacitor-Resistors," which appeared in the November issue, page 103, contained an error in the numerical example. After pointing out correctly that the total voltage across a circuit containing inductance and capacity is the sum of the vectors across these components, the author slipped into making a simple algebraic addition.

In the example: If the tubes of a radio set require 70 volts from a 110-volt power supply, what capacity will be required to drop the voltage? Voltage E across the condenser, in this case, will be the square root of the square of the voltage across the total circuit minus that across the resistive branch: $110^2 - 70^2$ equals E^2 . The solution: $12,100 - 4,900$ equals 7,200, which is the square of 85. The voltage across the condenser is 85, and the reactance required is $85 / .150$, the tube current. This is roughly 570 ohms, and reference to the chart shows that a 4.5 or 5 microfarad condenser will be required.

We thank Mr. R. M. McClung of Urbana, Illinois, for calling this error to our attention.

WORLD-WIDE STATION LIST

(Continued from page 254)

Delhi	WDDZ	6.190	11:15 am to 1:45 pm; 7:30 to 9 pm; 10:55 to 11:30 pm; 8 to 9 am; 10 to 11 am
Delhi	WDDB	7.275	6 to 9 am; 11:15 am to 3 pm; 8 to 8:30 pm; 8:35 to 9 pm
Delhi	VUD4	9.590	8 to 10:50 pm; 1 to 4 am; 5:30 to 7 am; 7:45 am to 3:45 pm
Delhi	VUD10	9.670	7:20 to 11:30 am
Delhi	VUD3	15.290	6 to 7:15 am
Delhi	VUD10	17.330	5 to 7 am
IRAN			
Teheran	EQB	6.155	9 am to 2:30 pm; 8 to 8:30 pm
Teheran	EQC	9.680	noon to 2:30 pm
IRAQ			
Bagdad	HNF	9.800	8 am to 3 pm
IRELAND			
Athlone		9.595	4:10 to 4:30 pm
ITALY			
Milan	ΔFRS	6.135	11:30 am to 4:30 pm
JAPAN			
Tokyo	JZ1	9.635	6 to 7:15 am
Tokyo	JVW2	9.675	2 to 5 am; 5:30 to 7:15 am; 7:30 to 9:40 am; 9:55 to 11:40 am; noon to 1:40 pm; 4:30 to 6:45 pm
Tokyo	JVW3	11.725	heard at 1 pm
Tokyo	JZJ	11.800	8 to 9 am
Tokyo	JVU3	11.897	5:45 to 11:30 am
Tokyo		15.105	heard at 7:30 pm
Tokyo	JZK	15.160	heard at 7:30 pm
Tokyo	JTL3	15.225	5:15 to 7:15 pm
Tokyo	JLP2	15.325	10:45 pm to 3 am
LEBANON			
Beirut	FXE	8.030	11 pm to 5:30 am
LUXEMBOURG			
	MCH	6.020	midnight to 3:30 am; 5 to 8:30 am; noon to 6 pm
	MCH	9.610	irregular
	MCH	11.115	
MARTINIQUE			
Pt. de France		9.705	heard at 5:30 pm
MALAYA			
Singapore		7.220	11:30 pm to 1:30 am; 3:30 to 5 am; 5:30 to 10:35 am
Singapore		9.548	8 to 9:30 am
Singapore		11.855	8 to 9:30 am
MEXICO			
Guadalajara	XEJG	4.820	heard at 8:30 pm
Mexico City	XEBT	6.000	8:45 am to midnight
Mexico City	XEWV	9.500	8 am to 2 am
Mexico City	XERQ	9.540	evenings
Mexico City	XEIT	9.555	
Mexico City	XEYU	9.600	late afternoons and evenings
Mexico City	XEQQ	9.680	evenings
Mexico City		11.950	evenings
Mexico City	XEUW	6.023	7 am to 12:45 am
MOROCCO			
Rabat	CNR	8.035	Sundays, 4 to 5 pm
Rabat	CNR3	9.082	2 to 5 pm; midnight to 3 am
MOZAMBIQUE			
Lourenco Marques	CR7BE	9.710	3 to 3:30 pm
Marquis	CR7BH	11.718	
NETHERLANDS			
Eindhoven	PCJ	9.590	2 to 3 pm; 8 to 9 pm
NETHERLAND INDIES			
Bandoeng		5.400	early mornings
Batavia	YDA	18.135	
NEW CALEDONIA			
Noumea	FK8AA	6.205	around 5 am
NEWFOUNDLAND			
St. Johns	VONH	5.970	10 am to noon; 3 to 8 pm
NEW ZEALAND			
Wellington	ZLT7	6.715	4:25 to 4:45 am
NICARAGUA			
Managua	YNDS	6.760	8 to 10 am; 5 pm to midnight
Managua	YNQW	6.910	evenings till 10:20 pm
Managua	YNBH	7.008	6 to 10 pm
NORWAY			
Oslo	LKJ	9.540	1:45 to 7 am; 10 am to 4 pm
NOVA SCOTIA			
Sydney	CJCX	6.010	on at 4 pm
Halifax	CHNX	6.130	
PALESTINE			
Jerusalem	JCKW	7.220	10:30 pm to 12:30 am; 2 to 3 am
PANAMA			
Panama City	HP5H	6.122	6 to 10:30 pm
Panama City	HP5A	11.696	7 am to 11 pm
Panama City	HP5G	11.780	daytime and evenings

ALL THE SCIENCE OF BASIC RADIO-ELECTRONICS

in one big 3 1/2 lb. book

WRITTEN FOR BEGINNERS

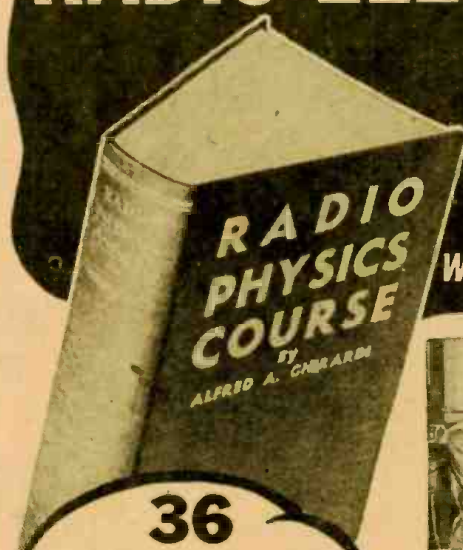

36 COURSES IN ONE
 If this big book were broken into monthly lessons and sold as a "Course" you'd regard it as a bargain at \$50 or more! In this convenient book form you get it for only **\$5 COMPLETE**



TRAIN NOW FOR THE BEST OF ALL POST-WAR JOBS!

A. A. Ghirardi's famous 972-page 3 1/2 lb. RADIO PHYSICS COURSE book with its 500 illustrations and 856 self-testing review questions can teach you basic Radio-Electronics from "scratch"—quicker, easier, and at far less cost than you may have thought possible! This ONE BIG BOOK (which is actually 36 Courses in One) has given more beginners their start in this fascinating field than any other book or course ever published! Also, it is used by more U. S. Army Signal Corps, Navy, and civilian schools and for more home study than any other book of its type on the market!

LEARN FAST — LEARN RIGHT!

Nothing is omitted, nothing condensed. Everything is fully explained and made as easy as A-B-C. Ask any radio-electronic man! You'll be amazed how quickly RADIO PHYSICS COURSE will help you master subjects that other courses make seem very complicated. And you'll be even more amazed to find that it gives you a COMPLETE basic training—ALL YOU NEED easier, better, and faster—at a total cost of only \$5 complete. Send coupon today. Examine this truly great book for 5 days—we guarantee to refund every cent of your money if not more than satisfied!

This is only a fraction of what RADIO PHYSICS COURSE brings you: First, over 300 pages devoted to a vitally important foundation in Basic Electricity... all made simple as A-B-C by clear explanations and over 150 illustrations; also broadcasting; Sound, Speech, Music; Radio transmission; Broadcasting stations; Receiving units; Vacuum tube theory, characteristics, construction, action; Detection; R-F amplification; Audio amplification; Super-heterodyne receivers; Tuning coils; Loud-speakers! Microphones; Power Supply units; Auto Radios; Aircraft Radio; Phonograph pickups and amplifiers; Public address systems; short wave characteristics and equipment; Photoelectric cells; Television; Sound movies!—and many other subjects and chapters!

Compares it with \$150 Radio Course!

"I had already taken a \$150 radio course, but since reading Ghirardi's RADIO PHYSICS COURSE book, I put the other one away. RADIO PHYSICS COURSE is the real book I need because it teaches so clearly."
 —Gerard Champagne, Montreal

WISHES HE'D BOUGHT IT SOONER

"Only wish I'd known about RADIO PHYSICS COURSE sooner. I have already learned more from a few pages than I got from almost two years of intermittent study from other sources."
 —R. L. Lucas, Fort Worth, Texas

"I have read quite a few texts on Radio-Electronics. Now after reading RADIO PHYSICS COURSE, I can see that I wasted my time on the other ones!"
 —C. W. Redish, Astoria, Oregon

RADIO'S GREATEST TRAINING BUY!

Technical Division, MURRAY HILL BOOKS, INC.
 Dept. RC-16, 232 Madison Ave., New York 16, N. Y.

Enclosed find \$5 (\$5.50 foreign) for Ghirardi's RADIO PHYSICS COURSE book; or send C.O.D. (in U.S.A. only) for this amount plus postage. If not fully satisfactory I may return it at the end of 5 days and have my money refunded.

Name

Address

City and Dist. No. State

5-DAY MONEY-BACK GUARANTEE

RADOLEK

Radio-Electronic Service Parts



Large stocks assure the finest and most complete selections of all available items at lowest prevailing prices. Thousands of active buyers depend on us for their entire Radio repair and replacement requirements. Because we understand service problems, every order is expedited for delivery in double quick time. Everything we do is planned for convenience and satisfaction to our customers. You will find it profitable to make Radolek your buying headquarters.

FREE BUYING GUIDES

Because of existing conditions we keep our customers right up to the minute on available merchandise by releasing supplements frequently instead of sending our regular Big Profit Guide once a year. Send the coupon now to get these Free Buying Guide Supplements as they are issued.

FREE!



FAST SERVICE!

RADOLEK CO., Dept. C-110
601 W. Randolph St., Chicago 6, Ill.

Please send FREE Buying Guide Supplements

NAME _____
ADDRESS _____

ORDER FROM RADOLEK

CRABTREE'S WHOLESALE RADIO

2608 Ross Ave.

DALLAS 1 TEXAS

Adson

RADIO CO.

Dept. C—221 FULTON ST. N. Y. 7, N. Y.

EVERYTHING FOR AMATEURS AND SERVICEMEN
COMPLETE LINE OF ELECTRONIC EQUIPMENT

Make your own Talkies

WITH PATD. **FILMGRAPH** RECORDER

CIRCULAR
FREE

and Instantaneous Permanent
PLAYBACK UNIT. Lengthy Recordings:
Clear, Powerful; Eliminates Titles.

MILES REPRODUCER CO., Inc. 812 BROADWAY, N. Y. 3 RC-1

Ted McElroy

World's Largest Manufacturer of
Wireless Telegraphic Apparatus

COMPLETE CENTRAL OFFICE EQUIPMENT

McElroy Manufacturing Corp.

82 Brookline Avenue • Boston, Massachusetts

FCC last month ordered reorganization of its engineering department, to speed up and facilitate handling of "the sharply increased post-war work load."

HI-FI AMPLIFIER CONTEST

(Continued from previous page)

The other pick-up was a needle-armature job featuring top-loading, high resonant frequency and low needle thrust. Needles were standard loud-tone with a portion of the shank removed to reduce the amount of inertia and were held by being pushed into a rubber bushing cemented inside the coil. Pole-pieces were widely spaced to reduce the harmonic distortion.

As the output of this device was extremely low, a special pre-amplifier had to be used (together with a resistance-capacity equalizer for the bass-cutting in records).

The amplifier used with this pick-up was a work of art, being spaced over three chromium-plated chassis (one for amplifier, one for power pack and one for field exciter). The speaker was a "G12" mounted in a very large flat baffle of highly irregular outline that caused comments as to its ability as an aeroplane. However, the tone was really excellent, there being a better ratio of "highs" to "needle scratch" than for any other amplifier.

SOME STATISTICS

The smallest power transformer used was a standard 60 milliampere type, the largest 225 Ma. and average size 118 Ma.

Average number of power chokes: 0.69. 45% had no choke and 14% had 2 chokes.

Magnetic pick-ups were used by 40 per cent of the entrants, while exactly half used permag. speakers.

In the final of the "popular" section, half the amplifiers were triodes in push-pull. Of the remainder, two used single-enders with beam-tubes. One of these, which won a prize in the technical section, is shown in Fig. 5.

CONTEST CONCLUSIONS

The average public has a very poor taste and needs educating, but definitely dislikes amplitude distortion in the high-frequency regions. The curves of the two

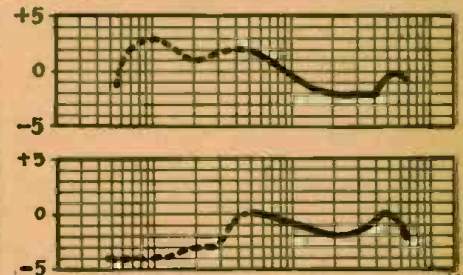

6 Fidelity curves of the two winning amplifiers vary considerably from the ideals.

winner winners are given in Fig. 6. These include pickup and loud-speaker load for the Section B winner, resistive load for the champion in Section A.

The average home builder knows very little of the finer points of layout—too much thought is given to "pretty" wiring.

Electrolytics are considered liable to voltage breakdown—many contestants used them in series to obtain a higher working voltage. No new circuit ideas appeared worthwhile. One amplifier incorporating cathode followers in the output stage was unhesitatingly condemned by public and technical judges (the former for lack of "lows" and the latter for lack of "highs"! although its electrical frequency response was very good.

Within a month after the conclusion of the contest, a very noticeable interest in amplifier design has arisen. A correspondence course in electro-acoustics has been offered by one educational institution; the subject of electro-acoustics has been incorporated in the diploma course of Applied Science at the Melbourne Technical College and manufacturers of sound equipment have started to display their "post-war" models of amplifiers, microphones and speakers.

WORLD'S BIGGEST CYCLOTRON

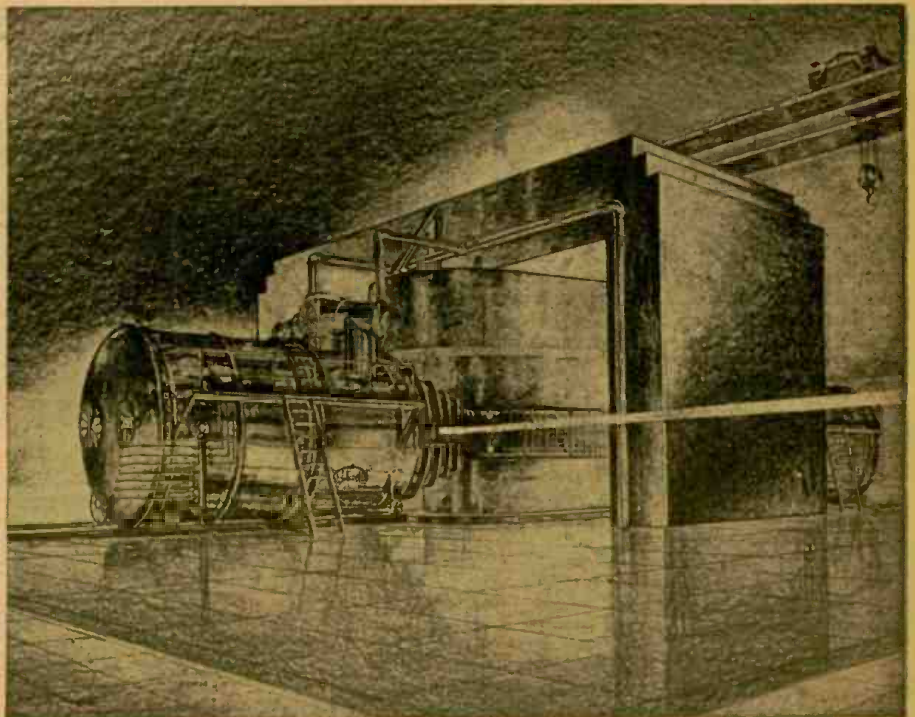

The University of California's 4,900-ton Cyclotron, which was building when all news of atomic research was blocked out by War Department order. Presumably it is now in action.

PORTABLE PHONO-RADIO

(Continued from page 265)

switch serves to connect the amplifier to either tuner or pickup and also to cut the "B" supply to the tuner when it is not in use. The filaments were wired in series and connected in place of a 50-ohm filament-dropping resistor used in the original amplifier filament circuit. Although the sum of the filament voltages is now 130 the available voltage to each tube is sufficient for proper operation.

For an antenna we used a few loops of wire tacked inside the case with provision for an external antenna to be connected through condenser C1. No external ground connection should be used with this type of power supply.

This circuit proved to be very efficient and is easily adaptable to any small set where economy of space and weight is of importance. The complete assembly makes a very satisfactory combination although we should like to make it clear that we do not recommend building such a set in separate units! The design of a complete tuner and amplifier in one step would likely lead to a different tube lineup and would certainly simplify construction.

SIXTY per cent of all radios manufactured for the postwar market should include FM, it was revealed last month by Frank Mansfield, director of sales research for Sylvania Electric Products. Basing his figures on a survey just completed by his staff, he stated that out of a potential market of 17,400,000 receivers, 10,700,000 prospective owners wanted FM.

ECHOPHONE
COMMERCIAL
"The Ears of the World"



MODEL EC-1 PRICE—\$28.50

NOW AVAILABLE AT ALL OUR BRANCH STORES

Write for New Complete Hallicrafter Catalogue

... FEATURES ...

- AC/DC operation-115/125 volts.
- Electrical bandspread on all bands.
- Beat oscillator for locating weak stations.
- Dial calibrated in megacycles with all important service bands indicated.
- Bandspread logging scale.
- Complete isolation for headphones.
- Self-contained speaker.

RADIO ELECTRIC SERVICE CO.
OF PENNSYLVANIA
N.W. COR. 7th & ARCH STS.
PHILADELPHIA 6, PENNA.

Phone:—
LOMBARD 6177
LOMBARD 1951

PRACTICAL HOME-STUDY RADIO COURSE

These men used this course to get into good radio jobs



FINEST TRAINING COURSE USED IN MANY SCHOOLS

"The radio training course is the finest up to date easy to understand course. . . . This course outlines practical work. We are using this course in our Topeka High School. It is wonderful." *Henry Ward, Jr., 622 Filmore St., Topeka, Kans.*



WORTH MUCH MORE

"You should get more money for your Course. The first week I studied it, I made \$10.00 repairing sets. I built my own test outfit from details given in this course. I have repaired 100 radios to date." Signed: *Robert C. Hammel, 120 W. 18th, Davenport, Iowa.*



COMPLETED IN 8 WEEKS

"I am very satisfied with the course. When I was at the twelfth lesson I started repairing radios. It took me two months to master your course." From a letter written by *Roger Lanzlois, 1679 Poupart, Montreal, Canada.*



MODERN, UP-TO-DATE

"I have found since taking your course how modern and up to date it really is. There is not one page in the whole course which anyone interested in radio can afford to miss. Your course paid me on the road to a well paid job and has repaid me many times." *Charles Alapach, 433 Elm St., Reading, Pa.*

AMAZING BARGAIN OFFER

In this large course-manual of 22 practical lessons, you have all the topics covered by the best \$100.00 radio correspondence course. Learn important fundamentals. Speed-up radio servicing. Includes hundreds of circuits, thousands of repair hints, many servicing short-cuts.

\$250 COMPLETE SPECIAL OFFER

RADIO TRAINING FOR HOME-STUDY

This practical home-study course will show you how to repair all types of sets faster and better, tell you how to open your own shop and run the business. The lessons are well illustrated, interesting to read, easy to understand and apply. No special previous knowledge is needed. The early lessons explain important principles. Other lessons cover test equipment, troubleshooting, circuit tracing, television, and every other important topic of radio and electronics.

SERVICING METHODS SIMPLIFIED

Learn new speed-tricks for radio fault-finding, case histories, servicing short-cuts, extra profit ideas. Included are many large lessons on the use of regular test equipment, explanation of signal tracing, oscilloscope, transmitters, P.A., television, recorders. Let this information save for you enough time on a single job to pay the full price of \$2.50 for the complete course of 22 money-making lessons.

A PARTIAL LIST OF TOPICS COVERED

Circuits, Auto sets, P.A., A.C., Fidelity, Using charts, Amplifiers, Tracking, I.F., Phase, Reactance, Impedance, A.V.C., Photo-cell. Test equipment, Meters, Analyzers, Tube testers, Signal tracing, Oscilloscope, Ohmmeters, Accuracy, Graphs, and hundreds of other topics.



EASY TO UNDERSTAND AND APPLY

The practical lessons making up this course-book are easy to follow and apply to actual radio jobs. Hundreds of radio facts that puzzled you will be quickly cleared up. You will find yourself doing radio repairs in minutes instead of hours—quickly finding the faults or making needed adjustments. Every new radio development of importance and thousands of time-saving radio facts are packed into this complete course-manual.

SATISFACTION GUARANTEED

Use coupon to order the Course for 10-day examination in your own home. Look over the material, read a few lessons, apply some of the ideas. Then decide to keep the lessons at the bargain price of \$2.50 (full price), or return the material and get a cash refund.

NO-RISK TRIAL COUPON

SUPREME PUBLICATIONS, 9 S. Kedzie Ave., Chicago 12, ILL.
Ship the complete Radio Servicing Course for 10 days use. I must be satisfied or you will refund my money.

- I am enclosing \$2.50, full price. Send postfree.
- Send C.O.D. I am enclosing \$..... deposit.

Name:

Address:

(Use Coupon or Write Order in a Separate Letter)

ALLEN Key Kits

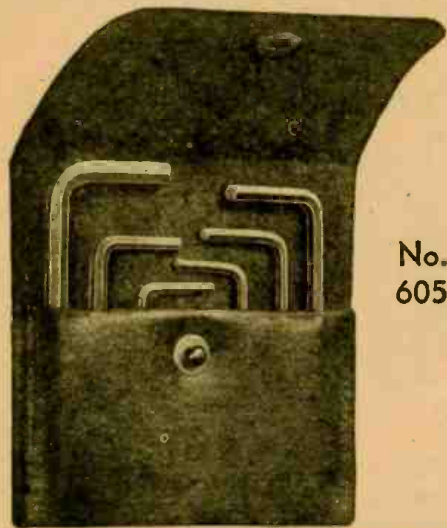

No. 605

VEST-PAC-KIT



No. 605 — Packet only 3" x 2 3/4" over-all contains 6 Hex Keys to fit hollow set screws in sizes No. 4, 5, 6, 8 and 10; also 1/4" and 1/8". Same keys fit socket head cap screws in sizes No. 4, 5, 6, 8 and 10. Most compact and serviceable little set you could ask for. List price, only 50¢.

Ask for complete listings of Allen Hollow Screw Assortments and Key Kits. Address inquiries and orders to Dep't. E,

THE ALLEN MFG. CO.,
HARTFORD 1, CONN., U. S. A.

New Radio Patents

Conducted by I. QUEEN

ELECTRONIC MOTOR CONTROL

Murray G. Crosby, Riverhead, N. Y.
Patent No. 2,380,948

THIS device controls the rotation of a motor in a required direction by the application of a small D.C. potential. As described here it is used in an automatic frequency control circuit for an FM receiver. The FM detector is shown at the left.

A 60-cycle source of voltage is applied to two similar amplifying channels. The output of each channel is connected to one winding of a differential-wound motor. Therefore, the direction of rotation is controlled by the operation of the proper amplifying channel.

When lead A is positive, the lower channel operates, because of the positive voltage on the third grid of the 6L7. At the same time, the 6F6 tube changes the phase of this voltage and causes a negative potential to appear at the third grid of the upper 6L7, so that it is cut off. When A is negative the opposite state of affairs exists and the motor will reverse.

It is found that 90 volts appears at the motor when a 5-volt D.C. change is made at A. The motor rotates in the proper direction until resonance occurs.

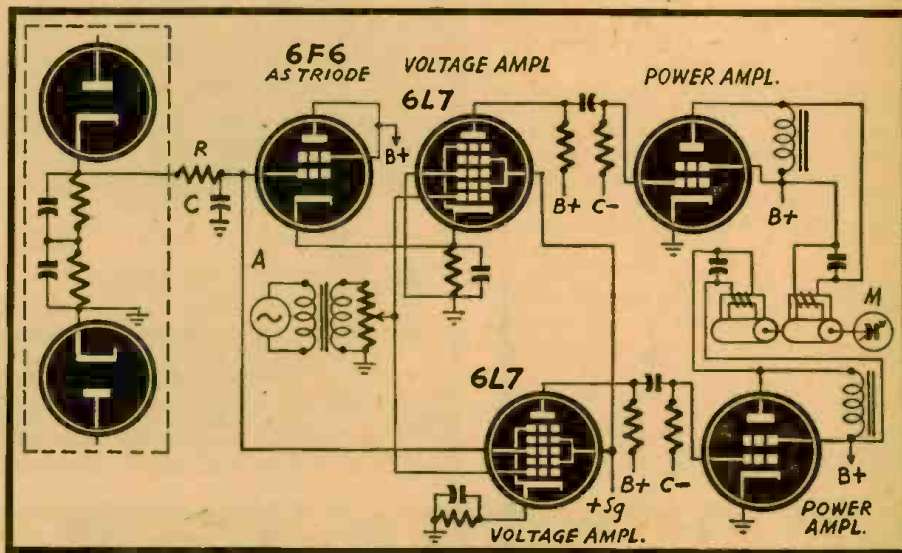

PULSE COUNTER

Sydney B. Ingram, Fairlawn, N. J.
Patent No. 2,384,379

THIS invention describes the use of vacuum tubes for counting rapidly recurring positive pulses. The tubes are connected in pairs so that when one of a pair becomes conducting, the other is cut off, thus maintaining this condition.

In the figure, assume that initially T1 and T5 are biased much beyond cut-off, while T3 is just below this condition, and note that all three are connected in parallel with reference to the input. Application of the first positive pulse then fires T3, and its plate current becomes relatively large. This current flows through R so that its

upper end becomes positive.

The results are: (a) The grid of T5 is raised to a potential just below cut-off; (b) the grid of T2 becomes positive, firing the tube and therefore again cutting off T1. It is then evident that the second positive pulse will fire only T5, and that succeeding pulses will activate succeeding tube pairs, one after another, in the same way.

It is possible to connect the series of tube pairs in a closed ring (as by connecting the T5 output to the T1 input). Plate circuits may include devices for recording the pulses.

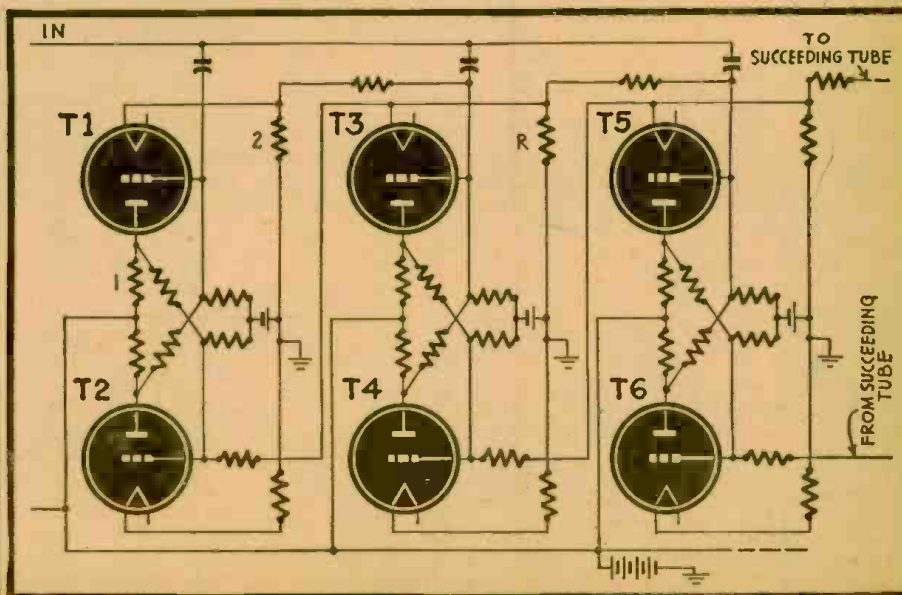

A.C. VOLTAGE MEASUREMENTS

(Continued from page 250)

multiplier for that rectifier and meter combination. Fig. 8 shows this simple arrange-

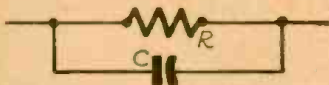

Fig. 8—Shunting system for fixed frequency.

ment. The impedance, Z , of such a circuit is:

$$Z = \sqrt{\frac{R^2 \times X_c^2}{R^2 + X_c^2}} \quad (3)$$

and the proper reactance value is:

$$X_c = \sqrt{\frac{Z^2 R^2}{R^2 - Z^2}} \quad (4)$$

The value of capacity to be used is determined from the value of capacitive reactance as follows for 60 cycle per second measurements (the most valuable set-up for the serviceman):

$$C = 2654 / X_c \text{ with } C \text{ in micro-farads} \quad (5)$$

The use of the copper oxide rectifier in A.C. measurements is not limited to such circuits as Fig. 2. A circuit employing only one rectifier element may be used.

We may also utilize a variation of the bridge circuit using only two rectifier elements in conjunction with two resistors to complete the bridge circuit as in Fig. 9.

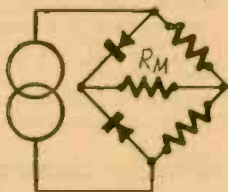

Fig. 9

The operation of these two circuits is understandable from the consideration given to the circuit of Fig. 2 above.

References

Applications and Characteristics of Copper-Oxide Rectifiers. By B. R. Hill, Radio-Craft, July, 1933. Dry Disc Rectifiers. Aerovox Research Worker, March 1943. Measurements in Radio Engineering. F. E. Terman, McGraw Hill Pub. Co.

DEFOREST AND THE PPI

Lee de Forest, "Father of Radio," was also instrumental in developing some of the features of its newest branch, radar. The swinging radial scan of the Plan Position Indicator type of scope is well known to all. What is not so well known is that de Forest filed a patent in July, 1937, which disclosed and claimed this cathode-ray tube scanning system.

The patent, U.S. No. 2,241,809, claims "A cathode beam tube, means causing the beam to swing back and forth in one plane through a common center point, and means for causing said plane to rotate continuously through 360 degrees about its mid-axis." Drawings indicate that the type of sweep was the one later used in the PPI.

Asked about the patent, Dr. de Forest said that he sold it to RCA shortly after it was issued. "At the time I filed," he said, "and even when the patent was issued, I knew nothing of Radar—had never even heard of 'the animal.' It was not strange that I did not recognize the peculiar value of this invention in Radar mapping. What a pity the application did not stay in the Patent Office about three years longer!"

Watch . . .

MILO

HEADQUARTERS for RADIO and ELECTRONIC EQUIPMENT

OF

NATIONALLY KNOWN PRODUCTS

Component Parts
Recorders
Testing Equipment
Sound Equipment
FM and Television Radios

Selling to Industrial Firms, Schools, Amateurs, Servicemen, etc.

Milo Features Trained Sales Technicians to Expedite and Handle Your Orders with Utmost Efficiency!

MILO
RADIO & ELECTRONICS CORP.

200 Greenwich Street
New York 7, New York

FIX ANY RADIO

Amazing New Invention



Find radio faults with a new simplified method. Repair all radios in minutes instead of hours. New, revolutionary different Comparison technique permits you to do expert work almost immediately. Most repairs can be made without test equipment. Simple point-to-point, cross-reference, circuit suggestions locate faults quickly and easily.

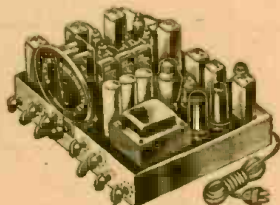

CHARTS, BLUEPRINTS, TESTS, HINTS, JOB SHEETS

Learn time-saving trouble-shooting short-cuts; find any radio fault with ease. Follow the tests shown on 24 large circuit blueprints. Over 1,000 practical repair hints. Hundreds of simplified tests using a 5c resistor and any filter condenser. Introductory material for beginners and to serve as review for experienced radio men. Several chapters on test equipment. Complete plan in manual form, 64 job sheets, data on all tubes, large size: 8½ x 11 inches. Schematics, pictures, charts. Sold on no-risk trial. Use coupon to order.

**NO TESTERS NEEDED
REPAIR ANY RADIO IN MINUTES**

This newly developed method tells you how to locate the source of trouble in any radio set without equipment. Make needed tests, measure voltage, trace the signal, by using only a 5c resistor, small condenser, and a crystal detector. Inject signals without any signal generator. Test parts by the new Comparison method. Test tubes without equipment. Repair any radio expertly following simplified picture plans. Improve your radio servicing ability. Data on all sets, portables, AC-DC, FM, recorders, intercoms, P.A. Examine and apply the plan for 10 days without obligation or risk. Send trial coupon today. →

NO RISK TRIAL ORDER COUPON

SUPREME PUBLICATIONS

9 S. Kedzie Ave., Chicago 12, Illinois

Ship postpaid the new complete Simplified Radio Servicing by Comparison Method manual for 10 days' examination. I am enclosing \$1.50, full price. I must be entirely satisfied or you will refund my total remittance.

NAME:RCJ

ADDRESS:



**LIGHT
AS A
FEATHER**

**UNGAR
SOLDERING
PENCIL**

...handles like a fountain pen and is a demon for speedy precision on intricate hard-to-reach jobs. And it takes plenty of punishment...weighs only 3.6 ozs., perfectly balanced; length 7 inches...heats in 90 seconds and draws only 17 watts. Unit complete with any of the four tips pictured sells at less than \$2.

No. 538 Chisel Tip, made from Elkaloy A, Tip 1/8" dia.

No. 539 Extra Hot, made from Tellurium

No. 536 Standard Tip, made from Hard Drawn Copper

Please order from your nearest Electronics distributor.

Ungar
Electric Tools, Inc.
Formerly Harry A. Ungar, Inc.
LOS ANGELES 54, CALIF.

SIGNAL GENERATOR COVERS ALL BANDS

(Continued from page 244)

lator can be obtained by connecting one lead to the chassis and the other through a small condenser (.0001 mfd.) to the "C" connection of the coil. At low radio frequencies the output will be sufficient to cause a small neon lamp to glow and to be visible on the screen of an oscilloscope. This connection is not used for ordinary tests because the oscillator would lack stability and selectivity.

These are but a few of the many tests that can be performed with the signal generator. More details on these tests and others may be found in almost any radio servicing book.

Parts List

CONDENSERS

- C1, C2—20-20 mfd. 150 V. electrolytic condenser
- C3—320 mmfd. variable condenser
- C4—3-30 mmfd. low-loss trimmer condenser
- C5—.0001 mfd. mica condenser
- C6—.5 mfd. 600 V. tubular condenser
- C7, C8, C11, C15—.06 mfd. 600 V. tubular condensers
- C9—Two insulated wires twisted together
- C10—.002 mfd. 600 V. tubular condenser
- C12, C14—.02 mfd. 600 V. tubular condensers
- C13—.005 mfd. 600 V. tubular condenser
- C16—.05 mfd. 600 V. tubular condenser

RESISTORS

- R1—250 ohm 10 watt wire-wound power resistor
- R2—250 ohm 25 watt wire-wound power resistor
- R3—1000 ohm 2 watt carbon resistor
- R4—50,000 ohm carbon resistor
- R5—100,000 ohm potentiometer with switch
- R6—10,000 ohm carbon resistor
- R7—250,000 ohm carbon resistor
- R8—500,000 ohm carbon resistor

- R9—1 meg. or higher resistance potentiometer with switch
- R10—500,000 ohm potentiometer with switch

TUBES

- 1—6J7 radio tube
- 1—6C8-G radio tube
- 1—35Z5-GT radio tube

MISCELLANEOUS PARTS

- 1—Audio transformer (secondary not used) or plate coupling choke, (T1)
- 2—S.P.D.T. Bat-Handle toggle switches
- 1—ICA precision vernier dial 4 inch diameter (No. 2169)
- 3—Black pointer knobs
- 1—Deluxe 0-10 dial plate for R9
- 3—Red large diameter molded Bakelite insulated tip jacks
- 3—Black large diameter molded Bakelite insulated tip jacks
- 1—2.5 mh. R.F. choke
- 3—"MIP" octal sockets
- 1—AMPHENOL 5-prong socket
- 2—grid caps for 6J7 radio tube and 6C8-G radio tube
- 9—5-prong 1 1/4" dia., 2 1/4" high Bakelite coil forms
- 1—1/2" red jewelled bracket with miniature base
- 1—Number 40 pilot lamp
- 1—Power cord with plug
- 1—Red test prod with alligator clip
- 1—Black test prod with alligator clip
- 1—Shielded cable with alligator clip
- 1—Penlight cell (size AA)
- 1—8" x 4 1/2" x 1 1/2" metal chassis
- 1—10" x 6" x 7" metal chassis with ventilation louvres on sides and hinged top
- 2—Mounting strips
- 25 ft. hook-up wire, coil wire, rubber grommets, hardware, etc.

The plug-in coil chart below is self-explanatory, all information being given.

PLUG-IN COIL CHART

COIL NUMBER	APPROXIMATE FREQUENCY	WINDING DATA	WINDING STYLE	COIL TYPE	OUTPUT SWITCH
1-B-1	34 to 11 Mc.	8 turns Self-supporting 3/4" diameter Tap 3 turns from G Large stiff wire	1	B	R.F.
2-A-2	24 to 7.5 Mc.	4 1/2 turns Spaced 1 1/4" diameter Center tap Number 28 wire	2	A	R.F.
3-A-2	14 to 3.5 Mc.	9 1/2 turns Spaced 1 1/4" diameter Tap 5 turns from G Number 28 wire	2	A	R.F.
4-A-2	5 to 2.5 Mc.	17 turns Close wound 1 1/4" diameter Tap 11 turns from G Number 28 wire	2	A	R.F.
5-A-2	2,500 to 900 Kc.	60 turns Close wound 1 1/4" diameter Tap 40 turns from G Number 28 wire	2	A	R.F. (or I.F.)
6-A-3	950 to 390 Kc.	100 turns 1 1/4" diameter Number 28 wire	3 (2 layers)	A	I.F.
7-A-3	500 to 210 Kc.	200 turns 1 1/4" diameter Number 30 wire	3 (2 layers)	A	I.F.
8-A-3	240 to 110 Kc.	400 turns 1 1/4" diameter Number 30 wire	3 (4 layers)	A	I.F.
9-A-4	120 to 65 Kc.	800 turns 1 1/4" diameter Number 36 wire	4	A	I.F.

LORAN-RADIO NAVIGATION AID

(Continued from page 237)

markers upon the traces, corresponding to the tiny lines that mark a stopwatch dial into seconds and fractions of seconds. The upper and lower traces correspond to the first 30 seconds and the last 30 seconds of

FIG. 4-C

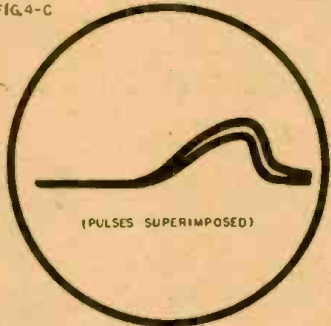
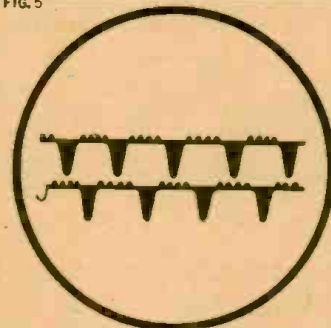

FIG. 5



the watch dial, with about 1/10 of a second lost between them in retrace.

Of these time markers only the 500-microsecond impressions are visible when the whole display—the slow sweep—is on the scope. If the navigator is going to measure time-differences to within a few microseconds accuracy, sections of the traces must be magnified. By means of the auxiliary circuits of the indicator, a short section of each trace may be selected, expanded and displayed in scale to occupy the entire width of the screen. The action is analogous to optical magnification:

Except in the case of the most recent loran models, the master and slave stations have specified positions on the horizontal traces before the navigator starts making magnifications and—ultimately—measurements. The master pulse must be located on the upper trace, and the slave on the lower trace. Manipulation of the framing switch, which can temporarily change the sweep recurrence rate slightly, by running the crystal clock a small amount of the time ahead or behind (thereby allowing the pulses to run left or right along the sweep, as desired), will determine the pulse locations.

When the whole of each trace is displayed, as it will be when the navigator turns on the instrument and sets his desired stations, the section "under the magnifier" is distinguished by being raised slightly over the rest of the trace, forming a *pedestal*. The pedestal on the top trace is fixed near the left-hand end of the trace, and the master pulse must be brought to this pedestal. Here again the framing switch is used, bringing the master pulse as close to the left end of the pedestal as possible. The master once set, the slave pulse is located similarly on the lower pedestal by means of a delay control switch, which moves the pedestal to the pulse. This display of the entire recurrence interval is known as the *slow sweep*. Amplification of the pulses, pedestals and their adjacent markers is the next step.

When he desires a loran fix, the navigator first consults his loran chart to get the information needed for identification of the stations in his vicinity. If in daytime, he will expect to find ground waves, to which we have referred all along, and if at night he will be on the alert for sky waves, which we shall discuss later. Next he sets his channel switch, the basic recurrence rate switch and the pulse rate switch (a station selector switch) and prepares to get his readings. The navigator then turns up the intensity to find his pulses, which he places on the pedestals, master on top pedestal and slave on lower pedestal. When these are situated as pointed out above, he goes through the following steps (see Fig. 4): 1—Turn the sweep

(Continued on page 291)

IT'S NEW! IT'S POST-WAR SUPREME Model 565 VACUUM TUBE VOLTMETER

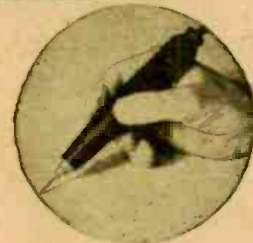

NEW PROBE Streamlined Hand Fitting Incorporating new High Frequency Diode

RANGES:

DC 0-1, 2.5, 10, 50, 250, 500
AC 0-1, 2.5, 10, 50, 250

EXTENDED TO 5000 VOLTS BY EXTERNAL MULTIPLIERS

INPUT RESISTANCE:

DC—80 megohms on 1 volt range; 40 megohms on 500 volt range
AC—40 megohms on 1 volt range; 20 megohms on 250 volt range

INPUT CAPACITY OF PROBE: 5 micro-micro farads

FREQUENCY RANGE:

Negligible frequency error from 50 cycles to 100 megacycles.

SUPREME INSTRUMENTS CORPORATION GREENWOOD MISSISSIPPI

Electricity

Models range from 350 to 25,000 watts, A. C. types from 115 to 660 volts, 50, 60, 180 cycles, single or three-phase and 400, 500 and 800 cycles, single phase. D. C. types from 6 to 4000 volts. Also available in dual voltage and special frequency types.

Onan

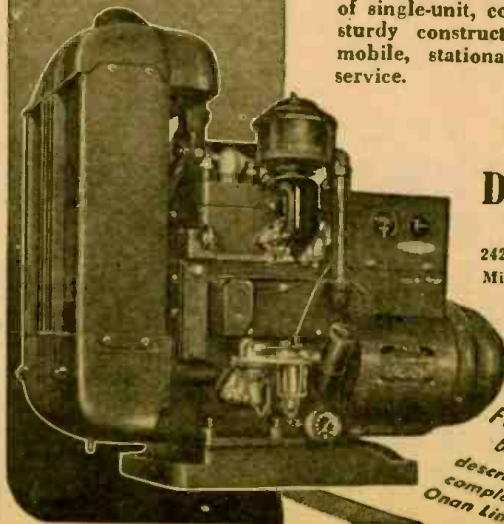

FOR RADIO AND ELECTRONIC APPLICATIONS

ONAN ELECTRIC GENERATING PLANTS supply reliable, economical electrical service for electronics and television applications as well as for scores of general uses. Driven by Onan-built, 4-cycle gasoline engines, these power units are of single-unit, compact design and sturdy construction. Suitable for mobile, stationary or emergency service.

Model shown is from W2C series; 2000 to 2500 watts; powered by Onan-built, two-cylinder, water-cooled engine.

D. W. ONAN AND SONS

2423 Royalston Avenue
Minneapolis 5 Minn.

Write For Folder 690-A describing complete Onan Line

VELOCITY P.G. DYNAMIC



THE FINEST MICROPHONES

AMPERITE

FOR PUBLIC ADDRESS & RECORDING

MICROPHONES THAT SURPASS THE HIGHEST REQUIREMENTS OF BROADCASTING, PUBLIC ADDRESS, AND RECORDING

KONTAK MIKES

Write for Catalog

AMPERITE COMPANY
561 BROADWAY NEW YORK, N. Y.

RADIO TARGET PLANES

(Continued from page 242)

cruises at 160 miles per hour, and otherwise resembles a combat airplane—an important factor in the psychological aspects of anti-aircraft training.

Take-off is accomplished by the use of a catapult, powered by compressed spring coils or rubber shock cord. After launching, the target is radio-controlled and is operated by elevator and rudder controls only. Landing is made by parachute, as shown in Photo 1. Parachute is released either by the control operator or automatically as a result of damage from hits.

The elevator and rudder servo controls remain in effect after the engine is stopped and the parachute released, providing the radio has not been damaged, so that "dead-stick" landings may be made in the event the parachute attachments are shot away.

The basic system of radio control for the target involves the use of an ultra-high-frequency carrier wave, modulated by five different audio frequencies. A small control box attached to the transmitter by means of a flexible extension cable, equipped with a stick to stimulate actual airplane control, is used to select the proper radio signals.

Four audio-frequency tones are used to control the target airplane in flight, one each for left, right, up, and down. A fifth frequency centers rudder and releases the parachute. Only one of these audio frequencies is used at a time. When one of the control frequencies is not in use, the fifth, or parachute frequency, is automatically switched on.

Installed in the target plane is a radio receiver selector, which translates the radio waves and actuates the servo unit by electrical energy. The servo unit provides the mechanical action to control the elevators and rudder. Operation has been so simplified that anyone without previous experience can learn to fly the target plane in 6 hours.

The procedure finally adopted uses a "mother plane," called the "CQ-3," a modified Beechcraft C-45. Trailing behind the PQ-14 at a safe distance, a pilot sitting in the co-pilot's seat holds the metal stick-control box in his lap (Photo 2). "Clicking" a lever on the upper left hand corner of the box will give the pilot the function he wants. Small lights, indicating the number of functions the PQ-14 will perform, gives the operator a check on the operation desired.

On the lower right hand side of the control box a small metal "stick," similar to an airplane control stick, is moved to give the up and down, and left to right movements desired of the PQ-14. Another switch is available on the control box for additional auxiliary operations. Coordination between the control plane and the target plane is instantaneous.

A frequency-modulated radio receiver relays the commands to a gyro-stabilized, remote flight control unit actuating hydraulic "muscles." This unit corrects the three functions of roll, pitch, and yaw; in addition it applies brakes, and maneuvers up to seventy-degree banks and dives.

Such auxiliary functions as throttle control, retracting and extending the landing gear, raising and lowering the flaps, are also actuated by radio waves setting in motion small electric motors which are integral parts of the plane.

The target planes are launched from catapults. These are smaller replicas of the

HARD-TO-GET PARTS

POWERFUL ALL-PURPOSE INDUCTION MOTOR

IDEAL FOR EXPERIMENTERS—101 USES



Sturdily constructed to precision standards, this self-starting shaded pole A.C. induction motor is powerful enough for a number of uses. Some of these are: Automatic Timing Devices, Current Interrupters, Electric Fans, Electric Chimes, Window Displays, Photo-Cell Control Devices, Electric Vibrators, Small Grinders, Buffers and Polishers, Miniature Pumps, Mechanical Models, Sirens, and other applications.

Consumes about 15 watts of power and has a speed of 3,000 r.p.m. When geared down, this sturdy unit will constantly operate an 18-inch turntable loaded

with 200 lbs. dead weight—THAT'S POWER!
Dimensions 3" high by 2" wide by 1 3/4" deep; has 4 convenient mounting studs spaced 3/8" long by 3/16" diameter, and runs in self-aligning oil-retaining bearings. Designed for 110-220 volts, 50-60 cycles, A.C. only. Shp. Wt. 2 lbs.

ITEM NO. 147 YOUR PRICE \$2.95

ULTRA MAGNET

LIFTS MORE THAN 20 TIMES ITS OWN WEIGHT
LITTLE GIANT MAGNET



Lifts 5 lbs. easily. Weighs 4 oz. Made of ALNICO new high-magnet steel. Complete with keeper. World's most powerful magnet ever made. The exciter and keeper will flood hundreds of excellent uses for this high quality permanent magnet. Measures 1 1/2" x 1 1/4" x 1/2".

ITEM NO. 159 YOUR PRICE \$1.50

GENUINE MICROPHONE TRANSMITTERS



Regular telephone transmitters taken from a telephone supply company's overstock. Work perfectly on 2 dry cells. Can be used on 2-wire systems, call systems, inter-communications, etc. Short-line telephone circuits, house-to-house or farm-to-farm phone lines, also to talk through your own radio or an concealed dictaphone pick-up. Useful replacement on battery-operated rural telephone lines.

THESE ARE GENUINE TRANSMITTERS, MADE BY KELLOGG, WESTERN ELECTRIC AND STROMBERG-CARLSON, excellent in appearance and operation. A remarkable value and one seldom offered in these times. Shd. Wt. 1 lb.

ITEM NO. 160 YOUR PRICE \$1.50

AMAZING BLACK LIGHT!

Powerful 250-Watt Ultra-Violet Source



The best and most practical source of ultra-violet light for general experimental and entertainment use. Makes all fluorescent substances brilliantly luminescent. No transformers of any kind needed. Fits any standard lamp socket. Brings out beautiful opalescent hues in various types of materials. Swell for amateur parties, plays, etc. to obtain unique lighting effects. Sub. only. Shd. Wt. 1 lb.

ITEM NO. 87 YOUR PRICE \$1.95

WESTERN ELECTRIC BREAST MIKE

This is a fine light-weight aircraft carbon microphone. It weighs only 1 lb.

Mike comes with breastplate mounting and has 2-way swivel adjustment so that it can be adjusted to any desired position. There are 2 woven strap on ones around neck, the other around chest. Straps can be snapped on and off quickly by an ingenious attachment.

This excellent mike can be adapted for home broadcasting or private communication systems. Dismounting breastplate, it can be used as desk mike.

Comes complete with 6-foot cord and hard rubber plug. Finished in anodized plate, non-rustable. Shipping weight, 2 lbs.

ITEM NO. 192 YOUR PRICE \$2.55

WATTHOUR METER

Completely overhauled and ready for immediate service. Designed for regular 110-volt, 60 cycle 2-wire A.C. circuit. Simple to install. 2 wires from the line and 2 wires to the load. Sturdily constructed in heavy metal case, 8 1/2" high, 6 1/2" wide, 5" deep. Westinghouse, G. E. or Ft. Wayne, Saginaw or other available make. Shd. Wt. 14 lbs.

ITEM NO. 33 YOUR PRICE \$4.95



HUDSON SPECIALTIES CO.

40 West Broadway, Dept. RC-1-46, New York 7, N. Y.

I have circled below the numbers of the items I'm ordering. No full remittance on \$5.00 or more. (Include shipping charges) is enclosed (NO C.O.D. ORDERS UNLESS ACCOMPANIED WITH A DEPOSIT.) OR my deposit of \$ is enclosed (20% required) this order C.O.D. for balance. NO C.O.D. ORDER FOR LESS THAN \$5.00. (New U. S. stamps, check or money order accepted.) Circle Item No. wanted.

Circle 47 159 160 87 152 33

Name

Address

Please Print Clearly

City

State

Immediate Delivery! SIGNAL CORPS TELEGRAPH KEY



Genuine U. S. Signal Corps key with switch to close contacts, polished durable enameled metal base mounted on a bakelite base, key lever is nickel-plated brass-silver contacts; Packed in new, original boxes. Shipping weight, 1 lb.

Army-Navy Type Headphones \$129

Save up to 70% on genuine U. S. Signal Corps headphones. These are the better \$10.00 headphones for only \$2.95. Leather-covered headband, detachable rubber cushions, lightweight construction, impedance 8000 ohms.

Each \$2.95

Order from your jobber or write "Info".

Write for our illustrated literature featuring all types of radio parts.

ARROW RADIO CO.

2205 W. Division St., Dept. D, Chicago 22, Ill.

MINIATURE TUBULAR CONDENSERS

We make them by the millions. Any size—capacity—voltage. Are humidity-proof. Give sustained operation in any climate. Withstand 30 day life test. Won Navy "E" award. Proven in famous VT Fuze. Tell us your needs.

GOOD-ALL ELECTRIC MFG. CO.

Since 1921 Opallala, Nebr.

Specialists in the manufacture of tiny paper tubular condensers for hearing aids, portable radios, electronic devices, etc.

Electrification may mean new radios for 3,500,000 farm families in the next five years.

catapults which permitted the successful launching of aircraft from all classes of carriers. An Army target plane launching is shown on the cover—Navy types in Photos 3 and 4. It will be noted that the shipboard target plane—called by the Navy a *drone*—is being launched from a regular ship's catapult (though with a greatly reduced charge). These drones, which could simulate suicide, dive bomber and torpedo-plane attacks, were controlled from the ship. After release, they would be flown back again over the ship or task force, giving the anti-aircraft gunners practice under highly realistic conditions.

The Navy has also been active in developing other pilotless planes, including jet-propelled types. Among these are flying bombs and a completely radio-controlled full-size standard fighting plane. Successful developments bear the odd names of "Glomb," "Gorgon" and "Gargoyle." The "Glomb," or glider bomb, carries a 4,000-pound bomb and can be towed by a Navy fighter plane in fully automatic tow. When released it can be directed into a target through radio control and television.

The "Gorgon" is a jet-propelled missile which can be carried by a bomber and sent into an enemy aircraft by radio control or by its own automatic target-seeking device. The "Gargoyle," also jet-propelled, carries a 1,000-pound armor-piercing bomb which, when released, automatically seeks and collides with a ship target. The ferocious appearance of these craft can be seen in Photo 5.

As early as 1940, successful demonstrations of pilotless aircraft had been made with a torpedo plane which was radio-controlled and television-directed from a control plane 10 miles distant. It launched the "ghost" plane's torpedo squarely into a maneuvering destroyer. Similarly, a dive

bomber was made to plunge through the center of a moving target. From these experiments several types of assault drones were developed, a number of which were used against the Japanese base at Rabaul.

King-piece of the Navy's experimental program is the ghost Hellcat, a modern, high-powered fighting plane that flies without a pilot, by the magic of radio control—as a forecast of the weapons with which the Navy hopes to meet the future.

The ghost Hellcat is the product of Navy experiment which began in 1922, and it is a development separate from the simpler target drones used by both the Army and the Navy for anti-aircraft training.

Operation of those small drones, or dro-nettes, require only five control channels: one for left rudder, one for right rudder, one to raise the elevators, one to lower them and one to cut the engine and release the parachute which permits the plane to float safely to earth.

The operator of the big drone—the ghost Hellcat—moves ailerons, flippers and rudder. He controls the throttle, retracts and extends the landing gear, sets the flaps, steers the tail wheel and works the wheel brakes individually. He can also operate a smoke recognition device and fighting lights for night control.

In operation, one "pilot" on the ground sits in a contraption resembling a barber's chair before a control panel set up in a truck. He takes the plane off, retracts the wheels and starts it circling the field. Then another "pilot" in a mother plane takes over and flies the ghost Hellcat on its mission. On return to the field, the control pilot in the air switches over to ground control after lining up the ghost plane for its approach to the runway. The ground operator then lands the plane and taxis it over to the line.

ORDER NOW!



NEW

**ECHOPHONE EC-1A
RADIO RECEIVER**

Be one of the first to own this popular set for short-wave and regular broadcast reception. Order now for earliest delivery. Many new features! Covers entire tuning range from 550 Kc. to 30 Mc. (550 to 9.85 meters) in 3 bands. For 110-125 volts AC-DC. Automatic noise limiter. Built-in PM speaker. Complete with tubes. Net. **\$29.50**

Other well-known receivers such as:

Hollicrafters S-20R.....\$60.00
Hollicrafters SX-25.....\$94.50
Hammarlund HQ-129X.....\$129.50

Net, F. O. B. Chicago (All prices subject to change)

ALLIED RADIO CORP.
833 W. Jackson Blvd., Dept. 2-A-6, Chicago 7

Ship ECHOPHONE EC-1A
 Enclosed \$..... Full Payment
 Part Payment
 Balance C.O.D.

Send additional information on Echo-
phone EC-1A.
 Send information on other Communica-
tions Receivers and Time Payment Plan,
without obligation.

Name.....
Address.....
City..... Zone..... State.....

Here is how you can acquire a better knowledge of electronics without trying to be a radio engineer . . .

... SEND FOR *Elementary
Engineering Electronics*

With Special Reference to Measurement and Control

by Andrew W. Kramer,

Managing Editor "Power Plant Engineering,"
Member American Institute of Electrical Engineers,
Associate Member Institute of Radio Engineers

Cloth, 344 pages, 259 illustrations — \$2.00 postpaid

This is a PRACTICAL treatment of principles and applications. It is NON-MATHEMATICAL—no equations beyond elementary-algebra level in the text—fewer than a dozen of these to be learned.

ORDER THIS UNIQUE BOOK NOW

Check, money order or cash must accompany order.

Instruments Publishing Co., 1129 Wolfendale St., Pgh. 12, Pa.

Enclosed is \$..... for copies of Kramer's ELEMENTARY ENGINEERING ELECTRONICS (at \$2 each).

Name

Address

Instruments THE MAGAZINE OF *Measurement and Control*

SUBSCRIBE NOW!

Instruments Publishing Co., 1129 Wolfendale St., Pgh. 12, Pa.

Enclosed is \$2.00 for which send me Instruments for ONE YEAR.

NAME

Position

Company

Products

ADDRESS

This unique magazine offers a BALANCED DIET of articles and special features appealing to production men as well as to research men—to executives and apprentices! It covers all subjects within the growing fields of Measurements, Inspection, Testing, Automatic Control, Metering, etc.

Many important methods have been disclosed for the first time in exclusive *Instruments* articles; many more will be disclosed through its pages.

Several outstanding books appeared first as serials in *Instruments*. The one advertised above is but one example.



EVERYTHING IN RADIO AND ELECTRONICS

R. W. T., world's oldest and largest Radio Supply House is ready again with tremendous stocks of sets, parts and equipment. You can depend on our quarter-century reputation for quality, sound values and super-speed service. Orders shipped out same day received. All standard lines already here or on the way, including: National, Hammarlund, R. C. A., Hallicrafters, Bud, Cardwell, Bliley and all the others you know so well.

Originators and Marketers of the Famous

Lafayette Radio

Radio Wire Television Inc.



100 Avenue of the Americas (Formerly 6th Ave) New York 13 Boston, Mass. • Newark, N. J.

R. W. T. DEPT. JA6, 100 AVENUE OF THE AMERICAS, NEW YORK 13, N. Y.

I want your big new post-war Catalogue.

NAME _____

ADDRESS _____

HAM? (CALL LETTERS) _____

ENGINEER? SERVICE MAN? STUDENT?

280

SHORTWAVE DIATHERMY

(Continued from page 245)

make provisions for stepping up the voltage and increasing the frequency. Thus, essentially, all apparatus used for this purpose will consist of the following three essential circuits:

- 1—Power supply: a step-up transformer
- 2—Oscillating circuit: this may be one of the following:
 - a—Spark-gap type—This consists of an inductance, capacitors and spark gaps. Damped oscillations are produced.
 - b—Vacuum tube or electronic type—Instead of spark gaps, high frequency oscillating tubes are used. Undamped oscillations are produced.
- 3—Patient's circuit: The patient is in a condenser field formed by two electrodes from the oscillating circuit.

SPARK GAP APPARATUS

Fig. 3 shows a typical circuit. Alternating current from the house line is applied to a step-up transformer through a regulating choke. Thus, the 110 volts are converted to about 2000 volts, with the frequency still at 60 cycles. The capacitors are of the mica type, and the spark gaps are of tungsten. The resonator is a standard D'Arsonval coil, and the secondary is a Tesla coil, thus forming the inductance. The inductance helps sustain the high frequency discharges issuing from the capacitors. The high frequency must be stepped up to a higher voltage. This is accomplished by the Tesla coil. Some types of spark-gap apparatus are also equipped with the Oudin coil shown in this circuit. The high frequency Oudin current is used for spark discharges in the patient's skin.

The physician finds it necessary to know how much current is passing through the patient's tissues. Therefore, a milliammeter is connected in series with one of the leads to the patient. Note that a double-scale meter is used. One scale is for the low readings (up to 1000 milliamperes); the other one records readings up to 4000 milliamperes.

The circuit is built into a cabinet which is provided with a panel board. On this panel are located the various outlets and regulating controls, including the spark gap regulators and spark gap cooling fans. There is a main line switch which turns on the power. The operator adjusts the voltages and the spark gaps. Thus, he can regulate the therapeutic dosage, standards for which have been established by the medical profession. The oscillations produced are applied to the patient through different types of electrodes which are described below.

Fig. 4 shows a typical 4-tube diathermy circuit. The power supply consists of transformers T1 and T2 and the rectifier tubes V1 and V2. It provides A.C. filament voltage and high D.C. plate voltage for the oscillator tubes (V3, V4). A choke (L2) and a condenser (C1) pro-

Fig. 4—A practical shortwave diathermy circuit. This operates at 8-16 meters.

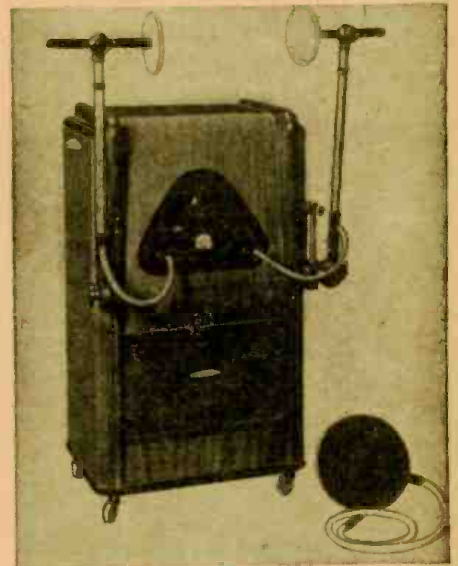

Photo C—High-frequency apparatus.

vide a filtering action for the power circuit. L1 is 15 turns, 2½-inch diameter, 3/10 inch between turns. L2, 4 turns, 1½-inch diameter, inside L1. Coils are wound with ⅛-inch copper tubing.

The oscillator circuit consisting of a pair of triodes (V3 and V4), a grid circuit and a tank circuit, produces undamped oscillations. This circuit is brought to reson-

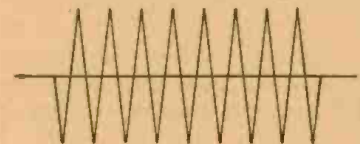

Fig. 2—Undamped electron-tube oscillations.

ance with the third and final circuit (the "patient's circuit") by means of a variable air condenser (C4). Maximum flow (resonance) is indicated by the milliammeter (M1). This type is a "silent" type, since no hissing noises are heard from the discharges of the spark gaps.

(Continued on following page)

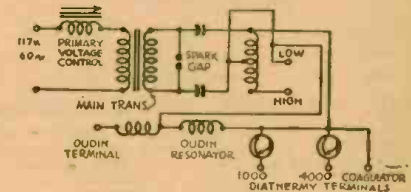
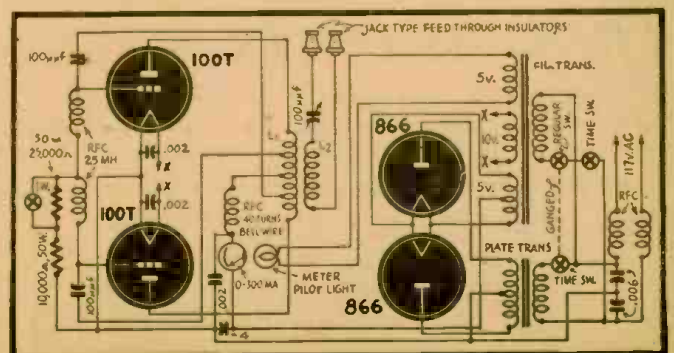

Fig. 3—Spark-gap equipment for diathermy.



The circuit is built into a cabinet provided with a set of controls and outlets, as shown in the photos.

As stated on previous page, the oscillations are applied to the patient by means of electrodes. Two general methods are in use, electro-magnetic induction and condenser field electrodes.

The first method involves the use of a flexible, insulated cable. The cable is coiled around the affected part or laid on the affected part in a flat, pancake fashion. Sometimes, the coil is enclosed in a bakelite drum which is attached to an adjustable arm. The drum is brought to the body and toweling placed between the drum and the tissue. Photo B illustrates this type. In this method, to which the term "inductothermy" has been applied, an electro-magnetic field is set up around the cable and eddy currents are created.

In the second method, electrodes are placed on opposite sides of the affected part of the body, with the body tissue as the dielectric. Various shapes and forms of electrodes are available to fit various parts of the body. Turkish toweling is placed between the electrode and the patient. The thickness of the padding is one of the determining features in the amount of heat produced.

The electrode is a flat plate usually made of brass. It may be flat or curved, depending upon application techniques. It is set in a covering of soft rubber or sponge rubber, which acts as an insulator. Some electrodes are set in glass insulators, and a screw is provided to set the electrode nearer or farther away from the insulator surface. Another adjustable type is shown in Photo C. There are also flexible types of electrodes shaped to fit specific parts of the body.

MEASUREMENT OF OUTPUT

The measurement of output is highly important in the application of short wave diathermy. Dosage and effects must be carefully regulated. Two general methods of measuring output have been used:

1—*Photometry*—An incandescent lamp is wired in series with the condensers in the patient's circuit. A photoelectric cell is used to measure the relative intensity of the lamps at resonance. The power required to give this light intensity is then obtained by measurement of the standard A.C. in use.

2—*Calorimetry*—A fluid is placed between the condenser plates. The temperature rise of the fluid in a given unit of time is determined. Mass and specific heat are then used to determine the output mathematically.

SERVICE NOTES

Service may involve testing of operation, output and the replacement of components. The following trouble points might have to be checked.

- 1—Defective tubes
- 2—Burned-out transformers
- 3—Defective line switch
- 4—Defective capacitors or resistors
- 5—Breaks in wiring or frayed insulation
- 6—Defective meter, giving incorrect readings or no readings at all
- 7—Defective variable tuning condenser in "patient's circuit."
- 8—Defective electrodes

TAYLOR TUBE MANUAL

This item was priced at 25c in the Available Literature release some months ago. This price was intended to apply only if the book was obtained from the plant. It is entirely free if the request is addressed to a local radio jobber or a Taylor Tube distributor.

G-E TUBE CHECKER

Quick, easy, accurate tube checking which saves you time and trouble and keeps your customers happy—that's the job the TC-3P is built to do. Line Voltage and tube quality, or shorts, may all be checked on one selector switch. Individually operated switches permit placing the proper voltage on the proper pin of the tube. The G-E Tube Checker is available in either the Portable (TC-3P) or Counter Model (TC-3). Write: Specialty Division, Electronics Department, General Electric Company, Syracuse, New York.

GENERAL  ELECTRIC

177-01

Electronic Measuring
Instruments

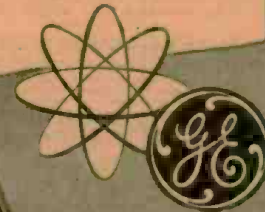

TC-3P

ALNICO-5
"MIRACLE METAL"
for
SPEAKERS

Cinaudagraph Speakers are known the world over for tone, stamina, engineering perfection and design. Consider the use of Alnico 5, newest miracle metal that gives 4 times the performance without weight or size increase, add this to scores of other Cinaudagraph Speaker achievements and you have the reasons why Cinaudagraph Speakers are "The Finest Speakers in all the World."

Cinaudagraph Speakers

A DIVISION OF Aircon

3911 SOUTH MICHIGAN AVENUE, CHICAGO

"The Finest Speaker in all the World"



TECHNOTES

ATTENTION, RADIO SERVICEMEN!

If you have found any common defect of a certain model and the way to repair it, have conquered a hard-to-find or hard-to-cure trouble, or have learned a new shortcut in radio servicing, send it to RADIO-CRAFT and receive a six-months' subscription for EACH such note we publish. Illustrated Technotes will receive a one-year subscription.

NEW TINY POCKET SIZE RADIO!



Slips in your pocket or purse—Wt. only 3 ozs. Complete. **READY TO PLAY** as shown with self-contained phone for personal use. Smooth, durable black and silver plastic case. Has patented **FRONT CRYSTAL NO TUBES, BATTERIES OR ELECTRIC PLUG IS REQUIRED.** USUALLY RECEIVES LOCAL BROADCASTS CLEARLY without outside aerial wire. **GUARANTEED TO WORK** when connected and used according to instructions sent with each radio. Can be used in homes, offices, hotels, cabins, bed, after hours, etc.

SEND ONLY \$1.00 (cash, money order, check) and pay postman \$2.95, plus delivery fees on arrival or send \$3.95 for domestic delivery. **IDEAL GIFT FOR CHILDREN OR ADULTS ALIKE!** Get your **PA-KETTE RADIO TODAY—NOW.** Dealers in most cities.

PA-KETTE RADIO COMPANY
DEPT. RC-1 KEARNEY, NEBRASKA

Do you need BINDING POSTS?



The **XL PUSH POST** with its Spring Action assures Constant Contact and quick connection. Manufactured in All Aluminum Type M at 12c each. Aluminum Body, Bakelite Top Type D1 at 15c each. Types CP or NP, ALL BRASS—STAINLESS STEEL SPRING & PIN, PROVEN BY 240 HR. SALT SPRAY TEST as NON-CORROSIVE at 25c each.

Manufacturers and Dealers Liberal Discounts

X. L. RADIO LABORATORIES
420 West Chicago Ave., Chicago 10, Ill.

Get Started in Radio

10 "HOW-TO-DO-IT" BOOKS



Get a solid foundation in radio by means of these 10c timely text books. Each clearly written, profusely illustrated, contains over 15,000 words. You'll be amazed at the wealth of information packed into these handy books. Excellent for reference—ideal for technical library. Your money back if not satisfied.

5 BOOKS for 50c
10 BOOKS for \$1.00
Sent to You Postpaid

No. 1—How To Make Four Doerle Short Wave Sets	No. 6—How To Have Fun With Radio
No. 2—How To Make The Most Popular All-Wave 1 and 2 Tube Receivers	No. 7—How To Read Radio Diagrams
No. 3—Alternating Current for Beginners	No. 8—Radio for Beginners
No. 4—All About Aerials	No. 9—Simple Electrical Experiments
No. 5—Beginners' Radio Dictionary (Leading Terms)	No. 10—Television

Remit by check or money order—register letter if you send cash or stamps.

RADIO PUBLICATIONS, 25F West B'way, New York (7)

OPPORTUNITY AD-LETS

Advertisements in this section cost 20 cents a word for each insertion. Name, address and initials must be included at the above rate. Cash should accompany all classified advertisements unless placed by an accredited advertising agency. No advertisement for less than ten words accepted. Ten percent discount six issues. Twenty percent for twelve issues. Objectionable or misleading advertisements not accepted. Advertisements for February, 1946. Issue must reach us not later than December 26, 1945.

Radio-Craft • 25 W. B'way • New York 7, N. Y.

AMATEUR RADIO LICENSES, COMPLETE CODE and theory preparation for passing amateur radio examinations. Home study and resident courses. American Radio Institute, 101 West 63rd Street, New York City. See our ad page 292.

EMBOSSED AND PLAIN BUSINESS CARDS, SPADA. 10 Lexington, Wethersfield 9, Conn.

CORRESPONDENCE COURSES AND SELF-INSTRUCTION books, slightly used. Sold, Rented, Exchanged. All subjects. Satisfaction guaranteed. Cash paid for used courses. Complete information and 92-page illustrated bargain catalog free. Write—**NELSON COMPANY, Dept. 2-39, Chicago 4.**

USED CORRESPONDENCE COURSES, EDUCATIONAL and Technical Books Bought, Sold, Rented, Catalog Free. Educational Exchange, Hensler, Ala.

MAGAZINES (BACK DATED)—FOREIGN, DOMESTIC arts, books, subscriptions, pin-ups, etc. Catalog 10c (refund). Cicero's, 863 First Ave., New York 17, N. Y.

RESISTORS—WIRE WOUND—5 WATT, ADJUSTABLE up to 3500 ohms. Five for \$1.00. **RADIOCO, 1110 Marshall Bldg., Cleveland, Ohio.**

NEW SCIENTIFIC MAGAZINE COPY FREE. Science Quest, Box 73R, Memphis 1, Tennessee.

German submarines attempted to mislead and confuse our radar by putting out "decoy" targets, says a recent U. S. Navy release. These were devices which would return a stronger radar echo than the subs themselves. In one instance an American destroyer was torpedoed while hot on the trail of one of these decoys.

PRECISION ALIGNMENT

To do a job of precision aligning on a good all-wave receiver you should likely want to allow for the impedance of the antenna, while aligning the oscillator and stages ahead of it. Instead of putting a number of condensers and resistors in series to create this effect, connect the receiver to an ordinary antenna and then connect the modulated R.F. output of your signal generator across the secondary of a loop antenna. The receiver antenna will pick up the radiated signal from the loop and the antenna circuit will be undisturbed. On some sets the antenna will have to be moved closer to the loop than on others. This will depend on the sensitivity of the receiver being aligned.

MILTON KALASHIAN,
Newburyport, Mass.

RCA-VICTOR MODEL 18K

Complaint: Intermittent reception on push-buttons although O.K. on manual tuning. If oscillator grid leak is not the trouble, check the 5600 mmfd. tubular condenser leading from the oscillator grid and mounted on the band switch. If found defective and a 5600 mmfd. condenser is not available, replace with a .005 condenser and realign push buttons.

W. D. Moss,
Washington, 2, D. C.

LATE R.C.A. MODELS

Some of the late models develop an intermittency especially on the short-wave bands. The tubes and condensers check O.K. Trouble in this case, lies in the tuning condenser which develops rust on the plates. Cure: Wash the plates with gasoline and blow with compressed air several times.

J. R. PADILLA,
San German, P. R.

VICTOR DUO

In this model the No. 1 lug on the I.F. tube socket is used as a terminal in the a.v.c. system. If GT type tubes with metal base bands or self-shielded tubes are substituted for the original 1N5G, the a.v.c. will be grounded and the reception seriously affected. Always clean the back of every hinge leaf on the loop. Do not use larger than the original capacities when replacing coupling condensers or hum trouble will appear. A ripple in the output may be due to the speaker voice coil rubbing against the pole piece. Check this first.

THOMAS C. RUMNEY,
Toronto 12, Ontario

R.C.A.-9

Symptoms: Set dead. All voltages appear normal. Audio tests fair. The 14,300-ohm screen resistor and 8000-ohm screen resistor to the cathode of the 35 tube have changed in value. Replace with the correct values (14,300 and 8000) and the trouble will be eliminated.

R. LeROY BLINN,
London, Ontario

ADJUSTABLE COIL

Adjustable oscillator coils with cathode tap are not readily available for 12SA7 and similar tubes. A standard adjustable oscillator coil can be used with excellent results by connecting the plate winding between cathode and ground or chassis. Connect the plate end of the winding to ground, B plus end to cathode. The secondary is connected in the usual manner, connection marked high or grid to the grid terminal; the other to ground. Coils of this type lend themselves readily to padder or tracker-type of circuits.

GERALD EVANS,
Ola, Arkansas

(Some of these coils might tend to oscillate too strongly thus necessitating the removal of several turns of the plate tickler coil.—Editor)

50Y6GT SUBSTITUTE

I have found a satisfactory substitute for the 50Y6GT as used in the Philco 42-1001 code 122 model. I wired an adapter consisting of an octal tube base and connected it to two 35Z5's which were OK except for filament between contacts 2-3. By then substituting a 35L6GT for the



50L6 power tube, the filament change was only 5 volts. The 35Z5's were mounted on a wall plug cover with two openings on a shelf near the chassis. Reconversion may be easily made in the future and no additional current is being used.

CHARLES F. HOUSE
Beckley, W. Va.

ZENITH 1005

Complaint: Distortion and high interstation noise suppression and low volume. Check the 220,000-ohm diode load resistor in the second I.F. can. They usually open up to 5 or 10 megs. Replace, and set is restored to normal.

LEWIS J. NEWMIRE,
Iowa City, Iowa

PHILCO PORTABLES

In case of noisy reception on the 1940-1941 models, solder together the tips of the spring leaves provided for external antenna connection. Also inspect the tube prong contacts in the sockets. My experience with these sets indicates a surprising amount of owner carelessness. About three out of five of these in for repair have bent rotor plates apparently caused by the owner reaching past the variable condenser to retrieve small objects dropped in.

THOMAS C. RUMNEY,
Toronto, Ontario

RADIO ON BUS LINES

(Continued from page 238)

tions of frequency-modulated radio to bus lines are not imaginary.

The departure is a pioneering experiment on the lines of the Washington, Virginia and Maryland Coach Company. It represents the first permit of its kind issued by the Federal Communications Commission and the frequency-modulated equipment was installed by engineers of the General Electric Company. It is the outgrowth of an earlier experiment of the Arnold Lines in using a two-way radio system to expedite the emergency handling of repair trucks to disabled buses. There is a central dispatcher's office equipped with radio and also several repair trucks (30-watt portable units) similarly outfitted, the radio network speeding a service truck with necessary repair parts, to the scene of any stranded bus.

The latest development of this company is to install FM equipment on one of its regularly scheduled buses. This radio-outfitted passenger vehicle will not be restricted to any one appointed route. Instead, before the tests have been finished, this first radio bus will have traversed 87 miles of different routes, embracing about 30,000 miles during the test period.

The company's headquarters are located in Arlington, Va., where a 250-watt FM transmitter has been installed. A water tower at near-by Bon Air almost overshadows the antenna and the transmitter, but for all practical purposes there is no integral relationship between the water tank and the radio outfit. Any message sent by radio from the company inspector's car is transmitted through the sending set at the water tower. A dispatcher, on constant duty at the control station in his office, intercepts the inspector's radio message.

The main objectives, as well as some of the offshoots of this radio-operated bus system, include the immediate dissolution of some of the public problems on emergencies, already recited; as a safety factor and as overall improvement of this form of transportation; and as a pioneering experiment for gleaming certain information in designing future frequency-modulated apparatus for the entire transit industry.

A parallel development to the experimental use of radio on the Washington, Virginia and Maryland Coach Company—an interstate transportation agency—is that of the Capital Transit Company of Washington, D. C., a purely city traffic company, operating both street cars and buses. A two-way radio outfit has been put into operation to cut drastically the time squandered by the tie-ups of street cars and buses. This radio equipment is employed to notify scout cars and emergency repair trucks of traffic delays, just as soon as they are registered on a machine. This so-called headway recorder automatically jots down any delay of a street car line, by a process of electrical checkers set up at 40 strategic places in the street-car company's system.

With respect to both the radio service of the Capital Transit Company of Washington, D. C., and the Arnold Lines of Arlington, Virginia, W. F. Kaylor, in charge of the supply services of the General Electric Company, is quoted as saying, "Experience with this kind of radio service between the Virginia bus headquarters at Arlington and supervisors' cars cruising company routes, proves that faster communication through radio will 'pay off.' Boiled down, this means improved transportation, the major objective of the industry."



Civilian RADIO JOBS Wanted

FREE WANT-AD SERVICE

TECHNICIAN—Radio electronics, electrical, 10 yrs. civilian army exp.; pos. as tester, troubleshooter, maintenance, construction. Frank Dado, 8918 Desarc Road, Ozone Park, L. I.

RADIO RESEARCH TECHNICIAN—Exp. radio comm., repair research, FM and AM training, math, electricity, radio. Brooklyn Tech graduate. A. M. Gendl, 2144 73 St., Brooklyn 4, N. Y.

A.A.F. FLIGHT RADIO OPERATOR—1200 hrs., logged flight time, 3 years N.Y.U. Knowledge promotional work, in ready-to-wear and public relations. Code speed 20 W.P.M. Accept anything with future and living wage anywhere. Jay Tenen, 801 Riverside Dr., New York City.

WOULD LIKE POSITION as a Radio Lab. assistant, 12 months of training in Radio-Electronics as a civilian. Desires position in Radio-Electronics field, preferred locations New England States or South, but would accept position anywhere in U. S. Eugene Krantz, 313 Messenger St., Johnstown, Pa.

ARMY AIR FORCE say I am radio and radar mechanic. I would like chance to prove it. Married, 31 years of age. What have you? William Blechman, 1262 Grant Ave., Bronx 56, N. Y.

RADIO VETERAN, 27, married, knowledge of radio theory, 3 years army experience with AM and FM theory. Desires position with future with reliable firm. Must have living wage. Box JN-446, % Radio-Craft, 25 West Broadway, New York 7, N. Y.

RADAR MAINT'CE SGT. Single (25) willing worker. Good technical background electricity, electronics, some drafting. Start \$40.00 reliable firm. Student evenings. Michael Bozohora, 130 First Ave., N. Y. C. 3, N. Y.

ONLY ARMY EXPERIENCE in radio mechanics, some code. Would like to continue in radio, servicing or apprentice preferred. Will work outside NYC. Walter Arkanoff, 497 Snediker Ave., Brooklyn, N. Y. D10-7281.

TELEVISION INDUSTRY; seeks future repair work, factory preferred, 3 years experience photography, 4 years army radio; written army separation qualifications; request interview. Harry Nemeroff, 737 Empire Blvd., Brooklyn 13, N. Y.

RADIO OPERATOR, Mechanic; desires pos. radio field; anxious, willing learn; 3 yrs. radio exp. A.A.P. Melvyn Medway, 1551 W. 11th St., Brooklyn 4, BE 2-4447.

ELECTRONIC LABORATORY ASSISTANT, 22, radar training, experience in radio repair and wire communications; skilled with tools; 2 years college business administration; studying E.E.; desires position with future in radio or television; Martin L. Garry, 2039 So. Blvd., Bronx 60, N. Y.

RADIO ELECTRICAL MECHANIC, 24, with 4 yrs. army exp. desires steady pos. \$40 to \$50 work in maintenance, wiring, trouble shooting; attended college. Daniel Palmer, 663 Fox St., Bronx 55; MO 9-0705.

RADIO SERVICEMAN, Bench and Outside, 29, married; 6 yrs. civilian, 4 yrs. army exp.; seeks ready employment. Max Kellman, 816 Crown St., Brooklyn 13; SL 6-5927.

A-I PURCHASING AGENT, married; 6 yrs. exp. electronics, radio, television; salary open; outstanding background in this field. Emanuel Blumberg, 1560 Danhill Road, Brooklyn 4.

EX-MARINE seeks job with future; radio preferred; exp. in estimating, pick-up and delivering; will accept anything with future. Sol Spielvogel, 768 Fox St., Box 55, D.A. 3-8277.

ELECTRONICS assist., 23, radio, radar maint., repair, television training, model bldg.; H.S. grad; ambitious, neat; must have advancement. A. Dinowitz, 1134 Stratford Ave., Bronx 59, N. Y.

RADIO engineer, 36, single; asst. or technician; graduate 2 yr. intensive course E.E. at university; communication major; executive background. G. Mont, 1643 Clay Ave., Bronx 37, TR 2-2463.

RADIO, radar technician; position electronics field; 3 yrs. Army exp.; grad A.A.F. technical schools; ambitious, desire advancement. L. Bender, 24 Amboy St., Brooklyn 13.

RADIO, 25, single; 3 1/2 yrs. maint. experience all types of radio, including UHF specialist; seeks pos. radio or electrical concern. Box JN-346, % Radio-Craft, 25 West Broadway, New York 7, N. Y.

ELECTRONICS, ultra-high frequency; instructed on theory, repairman, radar technician; background includes Dayton Aeronautical Engineering School, Cornell University, 25, single, Edward Berman, 1592 Jessup Ave., New York 52, Phone PR 3-0907.

ELECTRONIC technician, 22, married, 5 yrs. exp. electronics, radios, radar; position with future. S. Robbins, 1196 Eastern Parkway, Brooklyn 13, BE 3-0907.

MECHANICALLY INCLINED; attending radio-electrical school, evenings—prefer pos. allied field; ambitious; 24, married; living wage. Box JN-146, % Radio-Craft, 25 West Broadway, New York 7, N. Y.

RADIO OPERATOR, TECHNICIAN, 29, married; 1st class phone CW licenses; 8 yrs. civilian exp.; personnel and radio stations. Box JN 746, % Radio-Craft, 25 West Broadway, New York City.

12 YEARS IN RADIO prior to entry in service. Had my own business. Spent six months with Signal Corps Army (civilian) as a principal Radio Tech. Two years in Navy Air Base. Communications as Radio Tech. Materiel man on transmitters, U.H.F. and M. F. Gear, Control Tower and Radio Central Receivers and Remote line network. Dominic Daniels, 433 8th St., Carlstadt, N. J.

INSTRUCTOR—Graduated Radio Television Inst., New York 1940. Armored Force Radio Operator's School; Coyne Electric School, Chicago, 1945. Hold radiotelephone 2nd, restricted telegraph licenses. Experience—instructor at Coyne from May to November 9, 1945. Work New York City only. 24; married, slight handicap. Michael F. O'Connor, 55 Mt. Hope Place, Bronx, New York 53, N. Y.

VETERAN—age 28. Three years as a Group Radar Officer; Army Communications and Radar training and experience. 300 hours as Radar Navigator. Also four years office work with major oil company. Desire position with good opportunity. Robert V. Stewart, Captain, A.C., 510 East Maple, Independence, Kansas.

RADIO-TELEVISION TRAINEE; 22; vet.; 3 years college, math, and physics major; def. knowledge electricity; will attend night school. Martin Kostin, 17-9 Benson Ave., Brooklyn 14, BE-6498.

RADIO, radar technician; 24; 1 yr. civilian, 3 yrs. Army exp.; would like television training or radio-radar job with future. J. Kurusch, 1037 Kelly St., Bronx 59.

TECHNICIAN, Radar, Radio, Electronics, 30, 10 yrs. civilian, Army exp., college E.E. certificate. Desires position with future. Box JN 646, % Radio-Craft, 25 West Broadway, New York City.

TELEVISION or RADIO MAINTENANCE, Sales; 4 yrs. army radar, radio; 5 yrs. previous exp. television training, college, Wm. Stencheuk, 2514 Creston Ave., Bronx 58.

YOUNG—21; part-time, 5-11 p.m.; one year experience; assembling, soldering electrical devices; good references. Claude Frazier, 408 W. 129th St., N. Y. 27.

RADIO electronics; 6 years experience; all phases; knowledge drafting; desire position with future. Box JN-546, % Radio-Craft, 25 West Broadway, New York City.

NEWLY RETURNED; married; seeks opportunity with future sales, radio exp. Morton Kleinman, 286 Ft. Washington Ave., New York 32; WA 7-3234.

ELECTRONICS; sales, maintenance; 4 yrs. exp. instructor-supervisor radio, radar; desires television, V.H.F., V.L.F. field. Boris Kawallek, 1334 Eastern Parkway, Brooklyn 33, SL 6-5347.

SKILLED RADIO-RADAR Operator; 3 yrs. army occupation, receiving clerk; 2 yrs. civilian occupation; H.S.; ambitious, 25, married. Vincent J. Rubertone, 536 McDonald Ave., Brooklyn 18.

FUTURE DESIRED; 3 1/2 yrs. Army Quartermaster, sales ability, good worker, exp. shoe mfg., radio, no canvassing; will start \$50 week. Jack Benenson, 211 E. 200th St., Bronx 53.

NOW AVAILABLE

Test Equipment Made By
TRIPLETT—RCA—SUPREME
Deposit with order—Prompt delivery—Get acquainted offer—Special Kit 100 Resistors 1/2 and 1 W. Asst. \$1.75.

CHIEF ELECTRONICS
Hudson Valley's only Distributor
WRITE US YOUR NEEDS!
224 Main St. • Poughkeepsie, N. Y.

RADIO SERVICEMEN: RADIO PARTS—TUBES

BARGAIN PRICES—NO PRIORITIES
TUBES—125K7, 125Q7, 25L6, 50L6, 6V6GT, 50.65
TREMOR P.M. SPEAKERS, 4 or 5 inch 1.30
FILTER COND., 20-20 Mfd., 150 V.35
BY PASS COND., .01, .02, .05, 1-600 V.07
VOL. CONT., 1/2 Mex. W. SW., Tad. 3" Shaft.55
A.C. COND. AND PLUG SET, 6 in. to 1 Watt.25
RESISTOR KIT—50 Ass't. 1/3 to 1 Watt.
Write Today for Bargain Bulletin
RADIO DISTRIBUTING CO., Pasadena 18, Calif.



CANNON-BALL

Phones have kept in the lead for over twenty years through real performance. Write for folder R-1 illustrating complete line of rugged, unusually sensitive, dependable Cannon-Ball Headsets.

Scientifically Built
Heavy bar magnet
Greatly increases their efficiency.

C. F. CANNON COMPANY
SPRINGWATER, N. Y.

Headset Headquarters

Everything FOR THE SERVICE DEALER

We have, ready for immediate delivery, a complete stock of tools, replacement parts, inter-communication systems, public address systems, test equipment . . . everything in radio equipment for the progressive service dealer. For big profit items . . . for quick delivery . . . place your order now with Leo.

6 TUBE AC-DC KIT

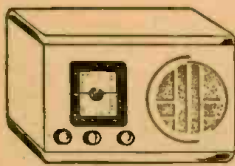

Complete, ready for assembly.

\$23.75

Cat. No. 7-691

A two-band, superheterodyne kit with all tubes, speaker, chassis, and all parts for easy assembly. Broadcast band from 540 to 1620 KC. Short wave from 5.7 to 18.3 MC. Cabinet, \$5.25.

WRL MULTITESTER

All purpose tester. Money back guarantee.

\$18.75

less leads

Cat. No. 16-439



Handles AC DC Voltmeter, DC Milliammeter, high and low range Ohmmeter. 3" meter with sturdy D'Aronsvval movement. Size 5 1/2 x 8 x 3 1/4.

Exclusive at WRL!

Our latest flyer . . .

12 page V-J edition of merchandise and radio values. FREE.

Handy Tube-Base Calculator . . . 25c

Giant Radio Reference Map, 3 1/2 x 4 1/2 ft. . . 15c

MAIL TODAY RC-1

Wholesale Radio Laboratory

744 West Broadway Council Bluffs, Iowa

Rush WRL Multitesters. Cost, \$

Send 6-tube AC DC Kits and cabinets. Cost, \$

I want a tube-calculator. 25c enclosed.

Ship me your radio map. 15c enclosed.

Send me your new V-J Flyer free.

Enclosed is \$; Balance C.O.D.

Name _____

Address _____

Town _____ State _____

I am an amateur; experimenter; service man.

We invite Industrial Inquiries for electronic equipment and devices of all kinds.

QUICK SERVICE FROM LEO
"same day" delivery service from the heart of the nation on anything in radio. Order today.

**Wholesale
RADIO LABORATORIES**

144-MC RADIO

(Continued from page 239)

adaptable to mobile use since it can work with a low plate voltage (less than 35 volts).

The tank coil is wound on a 1/2-inch form with eight turns of No. 14 bare copper wire, and is spaced to take up a total length of 3/4 inch. The band is correctly centered on the dial by spreading the coil turns apart or squeezing them together. The antenna coil is a single turn, ending in tip jacks for external connection. The tuning condenser is a two-plate Cardwell with a range of 0.2 to 2.8 mmf. The entire amateur band covers about half the total condenser rotation allowing ample room for the "marker" stations as well.

Some amateurs use two variable condensers in parallel, a large one to locate the band and the other to tune, as in Fig. 3. It is easy, however, to lose the band through accidental rotation of the larger condenser. Besides, a much lower Q exists with the large capacitance. We find that the use of a single small condenser gives better results although it is much more difficult to find the band originally. The radio-frequency choke RFC is wound with No. 26 wire on a 1/4-inch form with 30 turns. The total length is about 1 1/4 inches. RFC is a Meissner 19-2078 (8 mH) which prevents loss of energy in the output circuit. A one-megohm resistor provided super-regeneration. Some circuits may require experimentation with this component. Improper value may result in audible squeal or absence of hiss entirely.

For optimum results the following procedure can be followed to determine the tank "center" tap. Connect RFC to some point near the middle of the coil, then reduce the plate voltage (as by means of the potentiometer in Fig. 4) until the set just goes out of super-regeneration (hiss disappears). Now move RFC to a nearby point on the coil and try to find a point where super-regeneration still occurs, and so on.

The voltage node corresponds to the point where operation results with the lowest voltage. This is the correct position for the RFC connection. If RFC is held by its far end during the adjustment, there will be no need for soldering until the final point is located.

Headphones are used most of the time here, since this is necessary when the baby is asleep. The rear panel contains a phone jack and three binding posts for connection to "A" and "B" supply. Since the acorn tube works well with a minimum of 25 volts, it is ideal for mobile work with batteries.

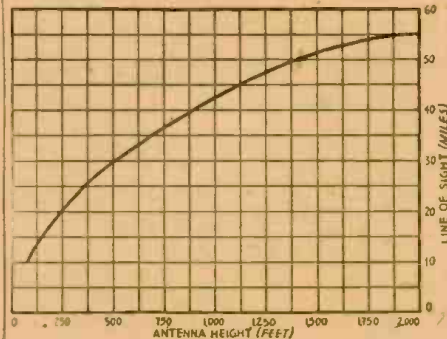
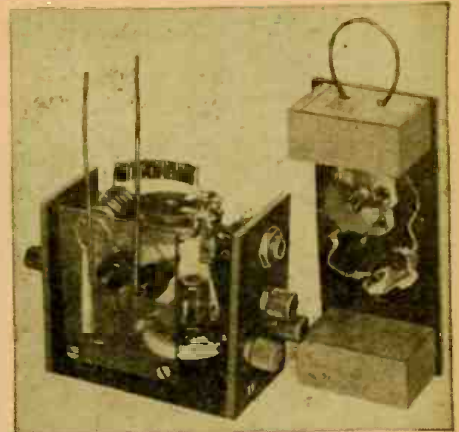

Fig. 1—Antenna height for given radio range.

For convenience a dipole antenna is used. Because of the great distance between antenna and receiver at this location (about 30 feet) coaxial cable feeder would prove



A rear-view photo of receiver and wavemeter.

both expensive and inefficient and double-feeders are rather difficult. Good results have been obtained with a single feeder tapped 7 inches from the center of the vertical 1/4-inch brass tubing dipole. Antenna length is 50 inches.

Representative stations heard with this receiver are shown on the map. Considering the poor location here these distances are not too bad. Our antenna is about 25 feet above ground. The roof here is not easily accessible for tests or changes and the

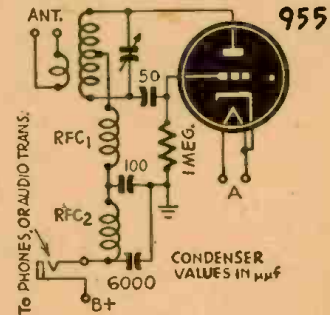

Fig. 2—The receiver is a super-regenerator.

low chimney will not support a high mast. Tall apartment buildings are numerous in this part of Brooklyn and high ground exists about two blocks north of us (at Lincoln Terrace Park). Note that no station to the north has been identified in several weeks of 2 1/2-meter operation. Local amateurs in other directions are coming in R7-R9 here-at-W1HCO/2.

FREQUENCY FINDING

The most difficult part of setting up the receiver will probably be finding the band. Here in the N.Y.-N.J. district we are fortunate in having "marker" stations just outside each end of the amateur frequencies. One beacon station continually transmits "dash-dot" a little below 112 Mc. A group of code stations at the high-frequency end is apparently on at all times of day and night.

Calibration by harmonics of lower frequencies is not very useful with "rush-boxes" since unmodulated signals are heard only as a reduction of noise. The most accurate method of frequency finding is the use of Lecher wires which will be described in the next article in conjunction with the V.H.F. transmitter.

The use of an absorption meter is ideal if the band is once located or if it is desired to duplicate the frequency of another receiver or transmitter. It consists of a tuned circuit with means for calibrating. Fig. 5

shows such a circuit. One turn of No. 14 wire ($\frac{3}{4}$ -inch radius) is used with a 35-mmf. tuning condenser and a trimmer condenser to set the band. (See photos.)

When the loop is brought near a super-regenerating receiver the latter will go out of super-regeneration into ordinary oscillation when both circuits are in tune. In this condition, only carrier whistles will be heard, most of them probably receiver re-radiation. It is advisable that the band be calibrated on the absorption meter before "improvements" are contemplated on the receiver since it is an easy matter to lose the band and difficult to relocate it.

Much interference on the V.H.F. is due to the use of "rush boxes" by both amateurs and V.H.F. listeners. These circuits are periodically interrupted oscillators which may radiate over a broad band with favorable radiators. They constitute, in fact, miniature transmitters when used with high voltages. Even a 955 can put approximately half a watt into an antenna.

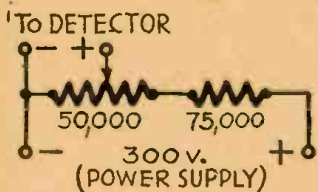

Fig. 4—Voltage adjustment is in power supply.

It is recommended that only low plate voltages be used with super-regenerators. No appreciable signal increase has been found to result from high voltages. It is also recommended that inductive rather than direct coupling be used. A single turn is generally satisfactory. Another idea used here at WHCO/2 is a SPDT switch which connects plate voltage either to the transmitter or the receiver, but not both at the same time. It is impossible to listen while the transmitter is on the air, anyway, when both units are close together.

As this issue prepares for press new amateur bands have been opened, and a 144-148 M.C. band replaces the original 112. To adapt our receiver to these new frequencies few changes are necessary.

The tank coil is now $6\frac{1}{2}$ turns. The antenna is 40 inches long and less coupling is found to give better results. A slightly different mark on our absorption meter designates the new frequencies.

Here in Brooklyn, airport and airplane messages (Floyd Bennett Field) come in at the low end of the band and a group of code stations mark the other end of the band.

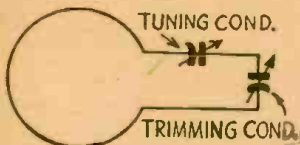

Fig. 5—Circuit of the absorption wavemeter.

The maximum QSO distance now possible should be less than before. This should prove advantageous for local contacts which will be unaffected otherwise if reasonable height can be attained. The shorter waves cast sharper shadows and are more easily reflected from relatively smaller obstructions.

There is not too much QRM at this location because of the poor V.H.F. receiving and transmitting location. We remember
(Continued on page 289)



Figure 3

SPEED UP REPAIRS WITH THESE G-C AIDS!



FREE
STEEL
CABINET

G-C Dial Belt Kits

Every Serviceman needs a G-C Dial Belt Kit. Save money—be ready for that repair job. Finest woven fabric replacements. Easy to install—no stretch—no adjustments. Supplied in kits of 25, 50, 100, 200 or 300 Belts in sturdy metal box with slide-in drawer. Free Belt Guide and measuring device.



G-C Dial
Drive Cables

G-C has a complete line of Dial Drive replacement cables. Available by the spool for prompt servicing of all sets. Every Serviceman should have a complete assortment. Best quality—extra strength. Preferred by Radio Men everywhere.



G-C Radio
Service
Cement

The best Cement for Speaker and Radio Work. Especially suitable for cementing replacement cones and repairing rattling and torn cones. Also used on glass to seal adjustments, hold wires in place, etc. Dependable, vibration proof, water-proof and fast drying.

Write for New G-C Catalog No. 146
and G-C Dial Belt and Service Book

Immediate Delivery on all G-C Products

Order From Your Radio Parts Jobber
ALWAYS ASK FOR G-C PRODUCTS



GENERAL CEMENT MFG. CO.
ROCKFORD, ILLINOIS

Available Radio-Electronic Literature

Manufacturers' bulletins, catalogs and periodicals.

A NEW SERVICE FOR RADIO-CRAFT READERS: In order to save your time, postage and incidental work in writing a number of letters to different manufacturers to secure the various bulletins offered, proceed as follows:

On your letterhead (do not use postcards) ask us to send you the literature which you designate. It is only necessary to give us the numbers. We will then send your request directly to the manufacturers, who in turn will send their bulletins or other literature directly to you.

191—NEWSFRONT.

Published monthly by Westinghouse. The first issue of this news letter has just been announced by this company. It is an informal informative four-page report. Requests for placement on their mailing list can be made through this column.—*Gratis to those in the trade or to interested parties*

192—INSTRUMENT MANUFACTURING AND SERVICE FACILITIES.

Distributed by the Nilsson Electrical Laboratories. This booklet describes the principles of the various instrument movement and covers the general operation, construction and repair of these instruments.—*Gratis*

193—AMERICAN STANDARDS PRICE LIST.

Published by the American Standards Association. A price list covering approximately 800 Standards in all fields and all branches of these fields, has been announced as available to anyone interested in this work.—*Gratis*

194—CHART.

Distributed by the Hytron Radio and Electronics Corp. A chart illustrating the step-by-step assembly of a radio tube, divided according to departments and subdivided in turn into individual operations.—*Available gratis to interested parties*

195—EXPANSIVE BIT.

Distributed by the Bruno Tool Company. This is a single sheet circular on the new

expansive bit for cutting circles in wood, plastic, metal, etc.—*Gratis*

196—INDUSTRIAL ELECTRONICS.

A 40-page GE book containing reprints of a number of articles which appeared in STEEL, written by an engineer in easily understood style. Diagrams, photos and charts are freely used.

The book describes the operation of rectifiers, relays, thyratrons, ignitrons, electronic heating and many other subjects. The entire series is devoted to fundamental principles and commercial application of these electron tubes and circuits. It is a very handy reference.—*Gratis*

197—ELECTRIC ENGINEER'S REFERENCE MANUAL.

Issued by the National Union Radio Corporation. A 147-page book in the pocket type, 4 x 9 $\frac{1}{4}$ inches, ring binding. Contains characteristic charts of National Union radio tubes, including cathode-ray and phototubes; base diagrams; ballast and dial lamp characteristics; lists of preferred tubes, tube symbols, numbering systems and cross-index of new RMA tube types. A number of pages of formulas and servicemen's aids are also included.—*Price \$1.00*

198—DIAL LOCKS.

A single sheet showing the different types of combination dial locks and tuning indicators has been released by The Radio Craftsmen. These locks are similar to those used on certain types of Signal Corps equipment. *Gratis*

POST-WAR Special



6 TUBE "SUPER HET" RADIO KIT

Complete, Including Attractive Walnut Cabinet.
Diagram Furnished. Uses 6SA7-6SQ7-6SJ7-
6SK7-25L6-25Z6.

ALL PARTS MOUNTED

To assemble, all one needs is a soldering iron
and 30 minutes of your time.

\$16⁹⁵

LESS
TUBES

Limited Quantity on Hand

TERMS: 10% DEPOSIT WITH ORDER—BALANCE C. O. D.

LIBERTY SALES CO., INC.

115 WEST BROADWAY · NEW YORK 13, N. Y.

FREE

It's my outright "get acquainted" gift—a bound book of 150 ELECTRICAL SHOP PRINTS & DIAGRAMS of full size 8½" x 11". It's yours FREE.



FOR MERELY EXAMINING THIS NEW BOOK ON Electronics Servicing

Now you can easily understand the principles, operation and servicing of electronic equipment—the newest phase of electricity and radio. 400 pages. Simplified explanations of electronic tubes for welding and other industrial application, phototubes, gas and vapor filled tubes, etc. A practical book for OLD-TIMERS or BEGINNERS in electricity or radio. Praised by educators, union officials, superintendents, etc.

SEND NO MONEY Here's my offer—send coupon below. I'll send you my new Electronics book for 7 days examination and my book of 150 Shop Prints which is an outright gift to you. If you like the Electronics book send \$4.95 after 7 Days; if not return the book and you owe nothing. In either case, however, the book of 150 Shop Prints is yours to keep free. Offer limited—rush coupon.

FREE GIFT BOOK COUPON

H.C. Lewis, Pres., Coyne Electrical School, Dept. 16-T1
500 S. PAULINA STREET, CHICAGO 12, ILLINOIS

Send me **ELECTRONICS FOR ELECTRICIANS OR RADIIOMEN**. Also send me bound volume of 150 Shop Prints which I am to keep FREE whether I keep the **ELECTRONICS** book or not. I'll either return the Electronics book in 7 days, and owe you nothing or send you \$4.95. If I keep the book I am also to get one year of technical bulletins free.

NAME _____ Age _____

ADDRESS _____

TOWN _____ Zone _____ STATE _____

More than eighteen million people are in the market for a new radio, says Frank Mansfield, director of Sylvania's continuing survey. The figure (18,700,000) represents a drop from the peak of postwar dreaming, when more than 20,000,000 people intended to get a new receiver.

ELEMENTS OF RADAR

(Continued from page 246)

quired p-r-f—into the cathode circuits of the two triodes.

Output energy is taken from the plate tank circuit by inductive coupling, and the R.F. pulses are fed directly to the antenna system.

R.F. OSCILLATORS

Because of the special types of tubes developed for radar transmitters and because of the simplicity of all other circuit elements at microwave frequencies, the R.F.

oscillate. Between pulses the tube does not operate.

Regardless of the type of R.F. oscillator, the output U.H.F. pulse will always occur at the established pulse recurrence frequency of the radar set. The duration of the pulse will correspond to the duration of the voltage control or modulating pulse.

TRANSMISSION LINES

Pulses reach the radar antenna system by means of U.H.F. transmission lines.

There are three general types of radar transmission lines: the parallel-conductor line, the concentric line, and wave guides.

Parallel-conductor lines consist of hollow copper rods maintained at a fixed distance—usually about 4 inches—from each other by means of insulating spacers or spreaders. This type of line is widely used at the lower radar carrier frequencies, chiefly because of its simple construction and low cost.

Principal disadvantages of this transmission line is its radiation loss as the frequency of operation is increased.

At higher radar carrier frequencies the concentric or coaxial line is used to minimize radiation losses.

This is a perfectly shielded line, consisting of an inner conductor of wire or tubing within and coaxial with an outer conductor of tubing. The inner conductor is spaced and insulated from the outer conductor by spacers or beads of pyrex, polystyrene, or other insulation material.

No electric or magnetic fields extend from the coaxial cable. Radiation losses are negligible.

Principal disadvantages of the concentric line are its cost for a given length of line, and the requirement of keeping the inner cavities sealed and airtight. Coaxial cable has an upper frequency limit, which varies depending upon the physical construction

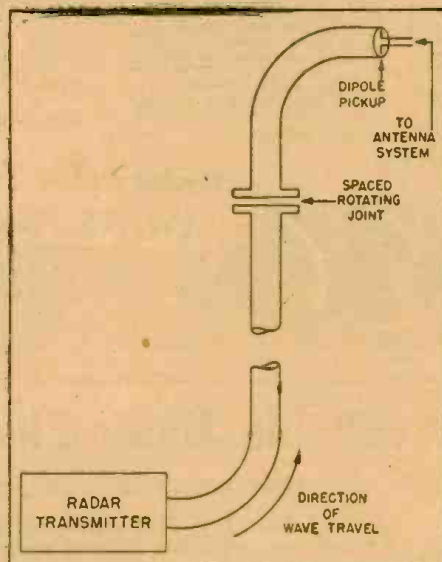

Fig. 6—Radar waveguide with rotating joint.

portion of the radar transmitter is essentially a simple unit.

At the lower radar carrier frequencies, negative-grid triodes are used for generating pulse-modulated R.F. signals. A typical circuit is shown in Fig. 4.

Grid and plate circuits of the push-pull triodes are coupled through interelectrode capacitance of the tubes, thus sustaining oscillations. Usually the grid, cathode, and plate circuits are tuned in U.H.F. oscillators. But it's only necessary that any two of them be tuned. The tank circuits consist of transmission rod or concentric sections of pipe. Metal surfaces are generally silver-plated.

There is no loading effect due to the connecting of the plates of the tubes to the tuned rods, since the triodes are effectively operating in series. Oscillations may be coupled out of such a circuit inductively, or directly from the cathode (Fig. 4).

There are several circuit variations of the basic negative-grid oscillator, but they all function in much the same manner.

The magnetron, however, requires an entirely different and much simpler oscillator circuit (Fig. 5).

Operation of the magnetron is based on the control of electron movement within a resonant cavity by means of an electromagnetic field. By whirling electrons at high speed within the magnetized resonant chamber or cavity and then controlling their speed and direction, the magnetron produces oscillations of considerable magnitude. The resonant frequency of the chamber or cavity determines the operating carrier frequency of the magnetron. Tuning, therefore, isn't permissible over any considerable range.

When the modulating voltage pulse is applied to the magnetron, it is permitted to

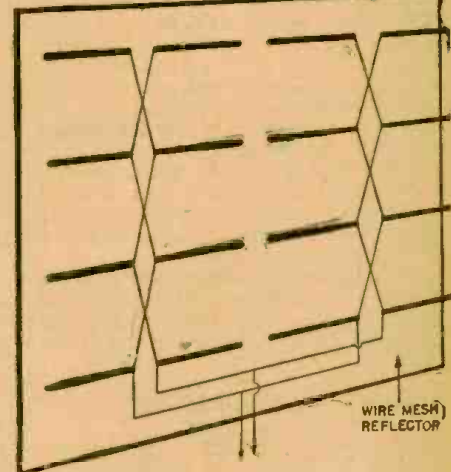

Fig. 7—Radar antenna—stacked dipole array.

of the line, and which prevents its use at the extremely short microwave lengths. Losses at such high frequencies are due mainly to capacitive effects.

Most effective and efficient means of microwave pulse transmission to the antenna is by the use of wave guides—a continuous conductor completely enclosing the electromagnetic waves.

Physical dimensions of wave guides are proportional to the operating wave length. Thus they are particularly appropriate for microwave energy transmission.

Since the wave guide has no center conductor, losses usually associated with this

Radiomen's Headquarters
BUFFALO RADIO SUPPLY
 219-221 Genesee St., Dept. C
 Buffalo 3, N. Y.

ALL KINDS OF RADIO TUBES IN STOCK
 AT BEST WHOLESALE PRICES

Mail in your orders for all types needed,
 not just the critical numbers, and we'll try
 to fill them completely!!!

ALL BALLAST TUBES—\$.37 ea.

Gold-plated Single Button Midget Carbon Microphone
 with stretched duraluminum diaphragm. Works in any
 position. Ideal for Signal Corps. Perfect for lapel
 mike or concealed or secret pickups. Super Special
 \$.95.

Sensational Speeder Wire Stripper that cleans solid
 or stranded wire instantly at rate of 1000 ends per
 hour—\$.52. General Electric 2000 ohm-per-volt 3/4"
 foundation meter with ohms and volt scales—\$11.00;
 66" highest grade standard type 3-section car aerials
 —\$1.10; with low-loss lead, \$1.50.

Bargains in Steatite Air-Tuning condensers 1/2"
 shafts. Regularly \$1.30 to \$2.25. Shaft length indi-
 cated. 25 MMF (1/2") \$.39; 50 MMF (3/4") \$.39;
 60 MMF (1/2") \$.49; 75 MMF (1/2") \$.49; 100 MMF
 (1/2") \$.54; 140 MMF (1/2") \$.69 ea.

100 Watt resistors, 100, 250, 3M, 10M, 11M, 20M—
 \$.35 ea. 10 WATT—1, 10 ohms, \$.10 ea. 300, 1M,
 12M—\$.15; 20 WATT—18 ohm, \$.10; 50 WATT—
 15M, \$.35; 80 non-inductive \$.10 ea. 250 CT—\$.20.
 All are IBC, Ward-Leonard, Ohmite, Westinghouse
 or equivalent.

Chassis cradles to support your work on the bench
 without danger of damage to coils, etc. Work can be
 rotated and locked in position at any angle—\$4.69.
 Webster Record Changers in the new post-war model.
 One of the finest and most fool-proof changers we
 have ever seen. Immediate delivery, \$35.95. Bullet
 Crystal Mikes, \$5.45. Bullet Dynamic Mikes, \$7.45.
 7 Ass't I.F. Transformers in Aluminum cans, \$1.98.
 Five ass't unshielded oscillator coils, \$.69. Bakelite
 A.C. plugs, per 100, \$2.00. Spring action Cubo taps,
 per twelve, \$1.00.

For immediate delivery—A complete stock of Supreme
 Test Instruments.

115V, 60 CYCLE HALF-SHELL POWER TRANS-
 FORMERS. At prices you can't beat.

4 or 5 Tube Sets, 650V, 40 MA. HT. 5V
 and either 6.3 or 2.5 Fil. \$1.40
 5 or 6 Tube Sets, 650V, 45 MA. HT. 5V Fil.
 and either 6.3 or 2.5 Fil. 1.55
 6 or 7 Tube Sets, 675V, 60 MA. HT. 5V Fil.
 and either 6.3 or 2.5 Fil. 1.70
 7 or 8 Tube Sets, 700V, 70 MA. HT. 5V Fil.
 and either 6.3 or two 2.5 Fil. 2.05
 9 to 11 Tube Sets, 700V, 100 MA. HT. 5V Fil.
 and either 6.3 or two 2.5 Fil. 2.75
 Filter Chokes, Cadmium Plated Straps, 2" Mount-
 ing, 200, 300, 400 or 500 ohms .49

AUDIO TRANSFORMERS: 1 Plate to Single Grid,
 3:1, \$.69; 1 Plate to Push-Pull Grids, 3:1, \$.69;
 Universal Output Tapped for Various Impedances,
 \$.79; Single or Double Button Mike Transformers,
 \$.69.

Condensers guaranteed 1 year. Prices in Lots of 10,
 either 1 type or ass't. 100 Mfd. 25V—\$.35; 50 Mfd.,
 150V—\$.45; 20-30 Mfd. 150V—\$.40; 20-20 Mfd. 150V
 —\$.30; 25 Mfd. 25V—\$.20; 10-10 Mfd. 450V—\$.45; 20
 Mfd. 150V—\$.20; 16 Mfd. 450V—\$.40; 12 Mfd. 150V
 —\$.15; 10 Mfd. 450V—\$.27; 10 Mfd. 50V—\$.15; 8 Mfd.
 450V—\$.23; 25 Mfd. 600V—\$.18; 1 Mfd. 600V—\$.10;
 .05 Mfd. 600V—\$.09; .02 Mfd. 600V—\$.08; .01 Mfd.
 600V—\$.07; .008 Mfd. 600V—\$.05; .005 and all smaller
 capacities in 600V rating—.07 each; 100 ass't. new but
 out-dated condensers, no guarantee, average 3 pounds
 —\$.90.

LOWEST PRICES • COMPLETE STOCKS
 FAST SERVICE
 STANDARD MERCHANDISE!

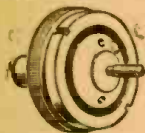

**"WONDER"
 ELECTRIC BUTTON**

Most interesting electrical appar-
 atus ever discovered. Make
 your own Telephone Amplifier
 Detectaphone. Transmit your voice or music to distant
 rooms. Perform hundreds of fascinating experiments.
 So tiny it can be concealed in dozens of places. Send
 \$1 now for button and free 5,000 word instruction
 booklet with 50 illustrated experiments. SPECIAL
 OFFER 6 buttons and booklets sent postpaid for \$3.
 Write now to

BUCK MFG. COMPANY North Aurora, Illinois



**Learn modern watch
 and clock repairing**

At home, spare time. Good field now
 ... security and contentment in fu-
 ture. Start part-time business and
 earn while you learn. Biology is
 precision instrument work ... a great
 and growing field. Sensational oppor-
 tunities. Easy self-instruction course.
 Low price. Money-back guarantee.
 Write now for Free Success Catalog.
 NELSON CO., 1139 S. Wabash Ave.,
 Dept. 2A39, Chicago 5, Ill.

element are missing. General efficiency is
 extremely high.

Electromagnetic waves may be propa-
 gated through wave guides in many differ-
 ent "modes" or field polarization arrange-
 ments. The guides may be either circular
 or rectangular in cross-section shape.

Since radar antenna systems are designed
 to rotate—often at a considerable physical
 distance from the actual radar transmitter
 —some sort of rotating joint is required.
 The use of a circular wave guide system
 permits the simplest method of connecting
 the rotor element (the antenna) to the
 stator element (the radar set).

A typical circular wave guide system is
 shown in Fig. 6, showing a number of fea-
 tures associated with this method of wave
 transmission. The output of the system is
 terminated in a small dipole, which func-
 tions as a receiving dipole. U.H.F. energy
 is then fed directly to the radiating member
 of the antenna.

ANTENNA SYSTEMS

A radar antenna system must have a
 number of important characteristics.

It must be highly directional, with an
 extremely narrow beam or lobe. It must
 be efficient, with all generated power from
 the transmitter radiated into space. It must
 be flexible of movement, so that the beam
 of pulsed energy can be directed at any
 angle in any given direction.

Simplest of radar antenna systems con-
 sists of two separate antennas: one for
 transmitting, one for receiving. Adequate
 shielding is required for such arrangements,
 to prevent transmitted pulses from over-
 loading the radar receiver and indicator.

Since the two antennas function *alter-
 nately*, it's possible to use a single antenna
 for both transmitting and receiving if a
 switching device is employed. This is the
 more usual form of radar antenna system:
 a single unit which radiates pulses and then
 receives echoes, using a transmit-receive
 switch to perform the electronic switching.

There are three general categories of
 radar antenna systems, all of which per-
 form the dual function of transmitting and
 receiving. The categorical division is rough-
 ly according to the operating frequencies.

At the lower radar carrier frequencies,
 a stacked array of dipoles with an untuned
 reflector (Fig. 7) is generally used. Broad-
 side arrays using as many as 16, 20 or 24
 center-fed dipoles are used. The larger the
 antenna array, the greater the concentration
 of energy within a single beam or lobe.

At much higher frequencies of operation,
 a very narrow beam can be created by
 installing a single dipole at the focal point
 of a parabolic reflector. The diameter of
 the paraboloid must be large in comparison
 with the operating wave length.

Wave guides can also be used with
 parabolic reflectors, where the guide ter-
 minates at the focal point of the paraboloid.
 At such high frequencies, however, the
 parabolic reflector may be replaced by an
 exponential horn for both transmitting and
 receiving.

In general, smallness is a desirable char-
 acteristic in radar antenna systems. This
 is necessary, because they are continually
 exposed to elements of weather and must
 be strong in structure to withstand wind
 and vibrations.

Since mechanical movement of the an-
 tenna system is necessary to scan wide
 areas, the structure—regardless of size—
 must rotate and swing up and down. This
 movement of the antenna is usually regu-
 lated by automatic-electric control. Selsyn
 motors and other electro-mechanical de-
 vices are used for this purpose.

Next month the technical operation of the
 radar receiver and indicator will be considered
 in Part III, the conclusion of **ELEMENTS OF
 RADAR.** To be concluded

**SENSATIONAL
 METER BARGAINS**



General Electric, West-
 ern Electric, Weston
WESTERN ELECTRIC—
 BASIC MOVEMENT 0-1
 MIL DC; SCALE
 MARKED 0-20 KILO-
 VOLT; DIAMETER 3 3/8".

No. 273 **\$3.95**

No.	Company	Description	Dia.
274	G. E.-Weston	0-10 Mil DC 2 1/2"	2 7/8"
276	Gen. Electric	0-200 Mil DC 2 1/2"	

**RADIO PARTS
 When You Need Them
 FAST!**

Order From Radionic's New Free
 Catalog!

- Lists Hard-to-Get Parts!
- Fills Your Radio and Electronic Needs!
- All Parts Available for Immediate Shipment!
- All Are Exceptional Values!

FOR YOUR FREE CATALOG
 WRITE DEPT. A4



**LAKE'S
 RADIO Cabinets & Parts**



for
**YOUR
 EVERY
 NEED!**

Portable Phonograph
 case of sturdy durable
 plywood, in handsome
 brown leatherette finish.
 14" wide, 9 1/2" high.
 Has blank motor board. As illustrated above
 specially priced at **\$6.95**

Also blank table cabinets of walnut veneer in
 the following sizes, with speaker opening on left front
 side. (Note: 7" has center speaker grill.)

#1	8 1/2" L x 5 1/2" H x 4" D	\$1.95
#2	10 1/2" L x 6 1/2" H x 5" D	\$2.75
#3	13 1/2" L x 7 1/2" H x 6 1/2" D	\$3.25
#4	15 1/2" L x 7" H x 5 1/2" D	\$2.50
#5	17" L x 9" H x 9 1/2" D	\$4.50
#6	21" L x 9 1/2" H x 10 1/2" D	\$5.50

*Speaker Opening in center of front side. Cabinets
 available in ivory color and Swedish Modern. Write
 for prices.

POWER TRANSFORMERS
 4, 5, or 6 Tube—6.3V at 2 amp. **\$1.49**
 50 Mill Power Transformer
 7, 8, or 9 Tube—6.3V at 3 amp. **\$1.89**
 70 Mill Power Transformer

All types of radio cabinets and parts
 are available at Lake's lower prices.
 A large stock is listed in our catalog.

SERVICEMEN—RETAILERS
 Join our customer list today.
 Write for our NEW, 12 page, illus-
 trated, elaborate catalog Order from
 Lake! You'll make no mistake!



LAKE RADIO SALES CO.
 615 W. Randolph Street, Chicago 6, Ill.

Radio Manufacturers Association has set
 up a section to assist amateur activity. Head
 of the department is W. J. Halligan, ham
 and president of The Hallicrafters.

AMPLIFIER MANUAL

By A. C. SHANEY

Chief Engineer, Amplifier Co. of America



For the Layman, Serviceman
Recordist and Engineer

Regardless of whether you are interested in the finest type of phonograph reproduction, high fidelity recording, sound-on-film applications, FM or AM programs, you will find invaluable information in this practical handbook. Written by the leading exponent of direct-coupled amplifiers who has spent more than 10 years improving and perfecting the famous Loflin-White circuit.

Explains the theory and practical application of:

- Variable Speed Non-Overloading Push-Pull Expansion
- Non-Frequency Discriminating Scratch Suppression
- Push-Pull Balanced Direct-Coupled Amplification
- Push-Pull High-Frequency Equalization
- Push-Pull Low-Frequency Equalization
- Push-Pull Volume Compression
- Automatic Volume Limitation
- Automatic Volume Control
- Calibrated V. U. Indicator
- Audio Spectrum Control
- Remote Control

If you are interested in the latest audio developments, you can't afford to be without this complete compilation of authentic articles on Direct-Coupled Amplifiers. 32 pages 8 1/2" x 11". Over 100 diagrams and illustrations.

Priced to Cover Cost of Printing and Mailing 25c

Send U. S. Stamps or Coin

AMPLIFIER CO. of AMERICA

396 BROADWAY

NEW YORK, N. Y.

SPCO

PLASTIC PLIERS



- Weighs 1 1/2 ounces!
- Absolutely shock-proof non-magnetic!
- 6,000 volt breakdown!
- Heat resistance 240 to 300 degrees!
- Tensile strength of material, 5000 lbs. per square inch!
- Pick up nuts, screws and washers without danger of shorting!
- Relocate wiring without disturbing magnetic fields while equipment is operating!

\$1.00

DEPT. G-1

ROBERTS ASSOCIATES, P. O. BOX 622, G. C. ANNEX, N. Y. 17

BUILD YOUR OWN RADIO

It's Easy . . . We Show You How!

4 tube T.R.F. Kit complete with tubes \$10.95

Multi-testers from \$7.95

We manufacture complete radio kits. Tubes and parts at special prices. Send for details.

RADIO KITS COMPANY

Dept. M 120 Cedar St. New York 6, N. Y.

HAZELTON INSTRUMENT CO.

Electric Meter Laboratory

Electrical instruments, Tube Checkers, and Analyzers repaired.

140 Liberty St., New York, N.Y.

Tel. BARclay 7-4239

Communications

TRIODE PROBE SIGNAL TRACER A TIME-SAVER

Dear Editor:

I made the signal tracer with the triode probe designed by Mr. D. T. Moore and it sure works. I certainly would recommend it to every radioman. Shortly after making it I found the trouble in a set oscillator in a few minutes that otherwise would have taken me a lot more time and trouble. I intend to incorporate in it a condenser tester, using the same 6E5 tuning eye, also an ohmmeter using the tracer power supply. I found quite a hum in the tracer, but remedied the trouble by putting a .1 mfd. cond. from line to chassis.

I would be very pleased to see some more articles on X-rays, also FM; if possible, an article on making a simplified FM receiver.

By the way, I sent you a letter which you printed in the February 1945 Mail Bag and a chap living in Lille, France, saw my

letter and sent me a reply. It was very interesting. He asked me about radio servicing in Canada, also wants to know about the different tubes we are using over here. He tells me they have a tuning eye called a 6AF7 with two sections, one for local stations and one for DX. He also says they had aluminum-wound transformers. Copper must have been scarce during the war. A radioman has to pass an elementary test before he can service Radios. This chap has been appointed one of the examining board and only about four out of twenty pass the test. It was quite a surprise to receive this letter from France as it shows how far Radio-Craft can really travel. He has been unable to obtain Radio-Craft for some time and misses it.

VINCE SHIPMAN,
Toronto, Canada.

VARIANT ON THE ELECTRONIC METRONOME

Dear Editor:

May I take this letter as a means of telling you that it's "Hats Off" to your magazine. It seems to me that each month all the departments keep getting better and better. I enjoy building many of the new circuits that you give us and feel that the magazine has been a wonderful thing for me—a small experimenter. Keep up the good work!

My daughter has wanted a metronome for quite some time. It seemed impossible for me to get her one. Then in the August, 1945 issue Radio-Craft gave us the article "Electronic Metronome," by C. C. Gray. I built this and had excellent results. I got to wondering about Mr. Gray's warning—interference with the radios near us. I made the changes shown in the accompanying diagram in the original hookup and ran a lead in the wire from it to the aerial of the radio we wanted to use. Not only did this prevent interference with outside radios,

but it cannot even be tuned in on any other radio in our house that is NOT on the same aerial. It has plenty of volume—I even tested it out on a four-tube Emerson and it was certainly loud enough.

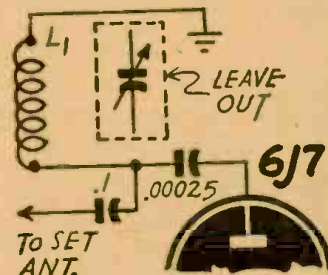

Thanks once more for a real "bang-up" magazine that has done so much for me.

WESLEY BRITTON,
Audubon, N. J.

NEW REPAIR STUNT FOR OUTPUT TRANSFORMER

Dear Editor:

I started reading one or two of your publications in 1927, and since then have built practically every circuit you have published in your magazines.

During the conflict just over I have been trying to help the neighbors and friends keep their radios in playing condition and have discovered a few odd ways to keep 'em going. The oddest one of all was a job on an RCA A.C.-D.C. with a burnt-out output transformer. I tapped the speaker

field down about a quarter of an inch and used the outside connection for the plate of the 50L6-GT. Then I wound two layers of No. 22 enamelled wire on top of the field and ran the leads to the voice coil. Believe it or not, it worked well!

I do not know whether this kink will be of use to anyone, but I consider it one of my pets because of its uniqueness.

HOMER E. COPLEY,
Portland, Oregon.

HE "NEVER SAW WORSE CORRESPONDENCE"

Dear Editor:

As your records will show, I have been a subscriber to your magazine for a long time. Therefore, it is apparent that I find it interesting and informative.

May I make one criticism of your article on page 85 of the November issue? You used too much print on the title of the article. Why limit your only too well justified censure to "GI Radio Servicemen"? I have never seen correspondence carried on with worse looking stationery and more poorly written letters than our own civilian branch of the profession uses. Why is it that we, as a class, are so slovenly and careless? Maybe you can stir the boys

to a little more dignified manner of carrying on correspondence.

MARCUS H. MOSES,
New York, N. Y.

(The editorial by no means intended to infer that ex-GI radio repairmen are more addicted to the use of poor or no letter-heads and sloppy methods of handling correspondence than many men who have been in the business for years. Mr. Moses is quite right. The point is that many GI's are attempting to break into the servicing game just at the present time, therefore their problems have been drawn more vividly to our attention—Editor)

BOOK REVIEWS

LA MODULATION DE FREQUENCE et Ses Applications, by E. Aisberg, Director, *Toute la Radio*. (Written in French.) Paper covers, 5½ x 8½ inches, 143 pages. Published by the Societe des Editions Radio (Paris).

Unlike most American works on the subject, this work deals with FM broadcast and reception as only one type of the application of frequency modulation, goes into detail in all cases where frequency is periodically varied at an audio or radio rate for any purpose, as for example the "wobblers" commonly used in signal generators.

A long introductory chapter deals with the theory of frequency modulation, with simple mathematics. Transmitters and receivers are described. A chapter is then devoted to panoramic receivers for monitoring larger or smaller spectra of frequencies, several circuits being discussed. The next chapter shows how the same techniques may be applied to the study of audio frequencies.

Frequency modulation applied to direction finding and aircraft-guiding devices, including automatic pilotage, are the subject of the next two chapters. Another chapter is devoted to FM telemeters and altimeters. The last two chapters discuss double modulation (use of simultaneous amplitude and frequency modulation on one carrier) in radio and television.

The workmanlike approach of the author is worthy of notice—though the range of subjects covered is wide, he is clear and precise on all points. Though specifically stating that he "does not consider it necessary to describe the various apparatus in too great detail," he goes to the extent of giving constants in most of his circuits, even coil dimensions and winding data, something seldom found in parallel American works. The effort is well worth while in the better visualization of the apparatus under discussion thereby rendered possible to the reader. Mathematical treatments of certain of the subjects, excluded from the text, are also worked out in the Appendix.

INTRODUCTION TO PRACTICAL RADIO, by Durward J. Tucker, Chief Engineer, Radio Stations WRR, KVP, KVPA. Published by the MacMillan Co. Stiff cloth covers, 6 x 8½ inches, 322 pages. Price \$3.00.

A text of radio fundamentals, this book differs interestingly from the mass of similar works in the attention it gives to mathematics. Simple in form—in most cases pure arithmetic or simple algebra—mathematical treatment is applied to practically all subjects, making the book an excellent reference for teachers of elemen-

tary classes or for the use of such classes or independent students.

The orthodox sequence of subjects is followed, though with considerable variation in treatment. The third chapter, entitled Ohm's Law, could have been called Practical Mathematics. Some of the sub-heads of this chapter are: Positive and Negative Numbers, Equations, Grouping Signs, Exponents, Radicals and Fractional Exponents. Chapter VII is entitled Kirchoff's Laws, and Chapter X, Alternating Current, is largely mathematical, introducing the only trigonometry met with in the book. Inductance, capacitance and impedance are given rather less space than would be expected in a work of this kind, though also taught with the aid of numerical examples.

Among other subjects treated are: Resistance Circuits, Direct-Current Power, Equipment Wiring, Magnetism and Electro-Magnetism, and Electrical Instruments.

A number of problems and exercises are given at the end of each chapter, as well as answers to the exercises in the body of the chapter. An Appendix includes tables of logs, of trigonometric functions and of powers and roots, as well as mathematical and an electrical glossary.

APPLIED NUCLEAR PHYSICS, by Ernest Pollard, Associate Professor of Physics, Yale University, and William L. Davidson, Jr., Research Physicist, the B. F. Goodrich Co. Published by John Wiley & Sons. Stiff cloth covers, 6 x 8½ inches, 249 pages. Price \$3.00.

Possibly the liveliest subject in the scientific world at the present time, the subject of nuclear physics is bringing forth a varied literature, ranging from the most esoteric treatments to atom-smashing pamphlets for corner-news-stand distribution. This book approaches from the technical rather than the theoretical angle. The authors state: "We aim at presenting the essential facts and methods of artificial radioactivity and transmutation in such a way as to be of service to the growing army of chemists, biologists, physicians and engineers, who, though not necessarily versed in the language of physics, are using the products of nuclear physics to further their ends in their own spheres."

A certain amount of simple theory is given in the first two chapters, describing the elements of atomic structure and properties of nuclear radiations. The third chapter discusses detection of nuclear particles, describing the Geiger-Muller counter and other types of detectors.

The Van de Graaff electrostatic generator, the cyclotron and the betatron are described and their action analyzed in the next chapter, "Methods of Accelerating Atomic Particles." The next three chapters deal with Radioactivity. Chapters 9 and 10 bring up the subject of transmutation and atomic fission, now so topical, and Chapter 11 is devoted to nuclear theory.

The chapters on radioactivity do not make easy reading for a person who has paid no attention to the subject in the past, but can be read with profit, even by the non-technical individual. The others can be followed easily by the radio-technician, who will find himself at home in the world of electrons and protons, of attractions, repulsions and electrically accelerated particles, which is also the world of the nuclear physicist.

A 2½ Meter Rig.

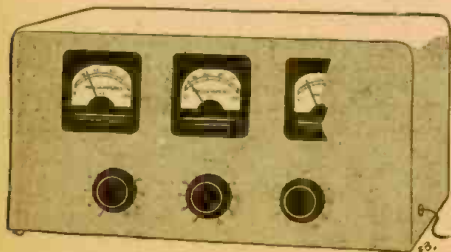

Suggested by: E. E. Youngkin, Altoona, Pa.

ATTENTION: RADIO MANUFACTURERS

America's finest humidity-proof condensers are made by Good-All.

Proven by the millions, in the famous VT Fuze, to withstand terrific shock and strain.

You will be elated over the sustained performance of our condensers in your radios. Free samples on request.

GOOD-ALL ELECTRIC MFG. CO.

Since 1921

Ogallala, Nebr.

In the Rocky Mountain Region

it's

RADIO & TELEVISION SUPPLY CO.

806 EUCLID AVE., PUEBLO, COLO.

"If we don't have it, we'll get it—
or it can't be had! Phone 5729"



MAGIC CUTTER

Cuts up to 4" hole in plastics, wood and metal. Wonder tool for amateurs and professionals developed by famous lab for own use. Send \$1 to: Dept. C-1

ROBERTS ASSOCIATES
P.O. Box 622, 6 C. AHEX, N.Y. 17

BUILD YOUR OWN RADIO SETS

All instructions including simple, easy-to-follow schematic diagrams. All kits complete with tubes.

4-tube T.R.F. \$10.75

5-tube Superhet \$17.95

Also available in quantities at special discounts. Write for our complete catalogue of hard-to-get parts.

NATIONAL RADIO DISTRIBUTORS

Dept. C, 140 West 42nd Street, New York 18, N. Y.

**FILTER CONDENSER BARGAINS!
BIG NEW CATALOG! WRITE FOR LIST!**

CHICAGO
Newark ELECTRIC Company

115-117 W. 45th St.
NEW YORK 19

323 W. Madison St.
CHICAGO 6

TEST EQUIPMENT

—SHIPPED FROM STOCK!—

SUPERIOR 400—electronic multimeter \$52.50

SIMPSON 260—volt-ohm-milliammeter 33.25

RADIO CITY 805—tube and set tester 89.50

TRIPLETT 666-H—volt-ohm-milliammeter 16.00

25% deposit with order, balance C.O.D.

Also many other types available.

SCENIC RADIO & ELECTRONICS CO.

53 Park Place New York City 7

144-MC RADIO

(Continued from page 285)

our troubles on the lower frequencies and therefore sympathize with anyone who doesn't feel kindly towards "radiationists." For example, there is the high-power local operator whose "CQ" we answered the other evening. Apparently and unfortunately we came on while he was experiencing severe QRM, for he unexplainedly and unexpectedly pounced on us as being the party whose receiver had been haunting the district for the past week or two with strong squeals and howls.

Of course this fellow had no possible way of knowing that W1HCO/2 had been completely QRT for the better part of the previous two weeks, the receiver and other apparatus having been in the office of *Radio-Craft* for photographic purposes in connection with this article. However, it was flattering to think that someone thought it possible for us to place a strong signal 2¾ miles away, using a few milliwatts from our unfavorable location.

SERVICEMEN'S HEADQUARTERS FOR QUICK DELIVERY!

We carry a complete line of Standard

Test Equipment
Amplifiers
Recording Devices
Phono-pickups
Microphones

and the hard-to-get equipment you have waited so long to obtain. Please send us your order or write us what you need. We will show our appreciation by rendering any helpful service to you.

This month's specials are on Weston!

VOLT-OHM MILLIAMMETER

Model 697
Illustrated

24.00 NET

Weston Analyzer
Model 772 type 6
\$49.50 net

Weston Tube Checker Model 777
\$49.50-net

Consult us on your many sound problems and requirements. Estimates and help cheerfully given. We have many standard systems now available, for immediate delivery. Priced from \$100.00 up, complete with tubes.

JACK GREENE

79 CORTLANDT ST. NEW YORK, N. Y.

ELECTRICAL BOOKS

shipped for
EXAMINATION

8
BIG BOOKS

SEND NO MONEY
MODERN ELECTRICITY
INCLUDING RADIO
AND REFRIGERATION

Here's great news for anyone interested in Electricity. NEW, up-to-date 19th Edition of Applied Electricity with new subjects fully covered, including blueprint reading, electronics, F. M. radio, fluorescent lighting, 8 Big Books sent for examination:

NEW Edition for Beginners and Experts

Over 3700 pages, 2700 illustrations and 134 tables in most complete electrical work we have published. Dynamos, motors, diesel plants, power stations, transmission — everything explained for easy understanding.

BIG FIELD! Big Demand!

Men who understand electricity are needed now in all kinds of industries. Practically every business depends on electrical knowledge, and men who know this subject make big money. Learn easily with these new interesting books. Send coupon for a set of books on approval. See how they will help you to get ahead faster.

SEND NOW A year's consulting privileges with our engineers now given to all buyers of this famous Cyclorama of Electricity.

AMERICAN TECHNICAL SOCIETY
Vocational Publishers Since 1898

American Technical Society,
Dept. E126, Drexel at 58th St., Chicago 37
Send for 10 days' free use. 3 volumes set of New 19th Edition, Applied Electricity, including a certificate entitling me to consulting privileges for one year. I will pay the delivery charges only on the books. If I wish I may return them in 10 days and owe you nothing, but if I keep them, I will send \$2.00 after 10 days, then \$3.00 a month until the total price of only \$34.80 is paid.

NAME

ADDRESS

CITY STATE

Please attach letter stating age, occupation, employer's name and address and name and address of at least one business man as reference. Men in service, also please give home address.

290

INDEX TO ADVERTISERS

Adson Co.	272	National Union Radio Corp.	224
Acrovox Corp.	270	Nelson Co.	287
Allen Manufacturing Co.	274	Newark Electric Co., Inc.	289
Allied Radio Corp.	279	Onan & Sons, D. W.	277
American Technical Society	290	Opportunity Adlets	282
Amperite Co.	278	Pa-kette Radio Co.	282
Amplifier Co. of America	288		
Arrow Radio Co.	278	RADIO SCHOOL DIRECTORY	
Audel & Co., Theo.	260	Page 292	
Bell Telephone Labs.	Back Cover	American Radio Institute	
Buck Manufacturing Co.	287	Candler System	
Buffalo Radio Supply	287	Capitol Radio Eng. Inst.	
Burgess Battery Co.	291	Commercial Radio Institute	
Burstein-Applebee Co.	291	Lincoln Engineering School	
Cannon Co., C. F.	283	Melville Radio School	
Capitol Radio Eng. Institute	253	RCA Institutes, Inc.	
Chief Electronics	283	Tri-State College	
Cinaudagraph Speakers, Inc.	281	Western Radio Institute	
Concord Radio Corporation	261	YMCA	
Coyne Electrical School	232, 286		
Crabtree Wholesale Radio	272	Radio Corp. of America	
DeForest's Training, Inc.	229	Inside Back Cover	
Free Want Ad Service	283	Radio Distributing Co.	283
General Cement Mfg. Co.	285	Radio Electric Service	273
General Electric Co.	281	Radio Kits Co.	288
Good-All Elec. Mfg. Co.	278, 289	Radio Product Sales Co.	265
Greene, Jack	290	Radio Publications	282
Hallicrafters Co., Inc.	227	Radio & Television Supply Co.	289
Hazelton Instrument Co.	288	Radio Wire Television, Inc.	280
Hudson Specialties Co.	278	Radionic Equipment Co.	287
Instruments Publishing Co.	279	Radolek Co.	272
Kluge Electronics Corp.	230	Raytheon Mfg. Co.	258, 259
Lake Radio Sales Co.	287	Rider, John F.	271
Liberty Sales Co.	286	Roberts Associates	288, 289
McElroy, T. R.	272	Scenic Radio & Electronic Co.	289
McGraw-Hill Book Co.	291	Sprague Products Co.	228
McMurdo Silver Corp.	267	Sprayberry Academy of Radio	225
McQuire Industries	222, 223	Superior Instrument Co.	255
Maedel Publishing House	291	Supreme Instruments Corp.	277
Milo Radio & Elec. Corp.	275	Supreme Publications	257, 273, 275
Miles Reproducer Co.	272	Terminal Radio	263
Murray Hill Books	268, 269	Triplett Elec. Instrument Co.	263
National Radio Distributors	289	Turner Co.	Inside Front Cover
National Radio Institute	221	Ungar Electric Tools, Inc.	276
National Schools	231	Wholesale Radio Laboratories	284
		X. L. Radio Labs.	282

ANTI-RADAR

(Continued from page 235)

from two stations on the same wave length or tried to use the radio while an electric razor was in use. The jammers attacked enemy radar receivers with radio waves modulated by random "noise," which drowned out any audible radio echoes from the radar's target and obliterated all signs of the target from the radar's screen, or scope.

An electronic jammer is a radio transmitter which bombards a radar with radio waves of the radar's frequency. These waves are of a very special type. Regular rhythmic radio waves are no good because the pip on the radar scope representing the target rides on top of the interference and remains visible. The jammers developed at Harvard's Radio Research Laboratory are complex instruments sending radio waves modulated by random noise, an irregular disturbance which makes a hissing sound, like distant surf, when heard through earphones. On a radar scope, this noise appears as "grass," a jumble of grass-like spikes which obliterates all target pips. If the radar is used for control of searchlights and anti-aircraft guns, jamming can effectively put them out of action. The most commonly used electronic jammer was an airborne and shipborne model called "Carpet."

For defensive purposes, particularly against enemy airborne radars, very powerful, long-distance, ground-based jammers were used.

Special forms of Window were used with great success in the later stages of the war. A 2-ounce bundle of about 2,000 strips, called "Chaff," dropped out of a plane and scattering in the air, looks on a radar scope like a heavy bomber; a bundle of 6,000 strips looks like three bombers. If dropped at regular intervals, one every 1,000 feet, or about 24 a minute, a trail is laid which looks like clouds of planes on a radar scope. Of course, a plane outside the cloud of Window can still be seen by the radar, but planes flying inside the Window "smoke screen" are effectively hidden.

Window can also be shot in shells from ships or vehicles, and it can be made to simulate a large fleet of ships.

Another form of window consists of 400-foot rolls of aluminum foil tape one-half inch wide, which unrolls like toilet paper in the air. This type is called "Rope" and is effective against long-wave radar. It was used principally against the Japs. Unlike Chaff, which is "tuned" to a specific frequency, Rope covers a broad band of frequencies.



LORAN-RADIO NAVIGATION AID

(Continued from page 277)

speed to fast sweep, No. 3 position (which is the first step in magnification, as it changes screen to show only the pedestals, their adjacent markers, and the pulses); 2—with fine delay dial, he moves the bottom pulse signal directly below the top, or master, one; then with framing switch, he drifts the pulses to the left of the screen, or until they are within the first 500-microsecond interval; 3—next he turns the fast sweep switch to position 2. This enlarges the left portion of the No. 3 fast sweep to the entire screen width. Here again he drifts the pulses to the left end of the screen. 4—Then he turns the fast sweep to position No. 1, which further magnifies the left portion of the No. 2 fast sweep. Now he adjusts the fine delay to place the bottom pulse approximately beneath the top one, and, if necessary, adjusts the oscillating frequency to minimize drifting of the pulse. 5—He throws the receiver on-on-off switch to the center position, which eliminates trace separation. Adjusting the gain knob and the amplitude balance controls until the two pulses are the same amplitude and about one and a half inches high, the navigator then uses the fine delay control until the left edges of the pulses are superimposed from the bottom to the top (Fig. 4-c).

After throwing the receiver on-on-off switch down, the navigator is ready to take his readings, as follows: 1—He sees two distinct sizes of markers. The longer ones represent 50-microsecond markers (see Figs. 5 through 7), and the smaller markers, between the longer ones, represent 10 microseconds each. Starting with one of the downward projected 50-microsecond markers on the lower trace, he counts the smaller markers to the next 50-marker. In case the larger marker falls between two 10-microsecond markers, the navigator interpolates. In step 1, as shown by Fig. 5, the reading would be above 26 microseconds, or two 10-markers plus 6/10 of another. 2—He turns the fast sweep to position 2, flips the receiver on-on-off switch up, turns the gain fully counterclockwise, and adjusts trace separation to about a half inch. Here again he sees two sizes of markers, the longer ones being the 50-microsecond markers and the shorter ones representing 50 microseconds each. He counts between the long marker on the lower trace and the long marker on the upper trace, to the nearest intervening smaller marker. Each of these represents 50 microseconds. In Fig. 6 the reading would be 300 microseconds, or 6×50 . This is recorded alongside the reading in 10s and units. 3—In this step the sweep speed is turned to slow and the fast sweep to position 3; here the navigator counts the markers on the lower trace left of the pedestal, subtracting the two markers to left of pedestal on the upper trace (see Fig. 7). Each represents 500 microseconds. Totalled up, the reading would be, as shown in the figures, 3000 plus 300 plus 26, or 3326 microseconds, which corresponds to a line of position on a loran chart. The figure may be used in entering the loran tables, which provide latitude and longitude positions, which, linked, will give the same line-of-position as shown on the special chart.

This done the navigator turns the gain up, centers the amplitude balance, and sets the channel, pulse recurrence rate (station selector) switches for another pair of stations, a reading from which will give him

(Continued on page 292)

Now available—
Your guide to precise
usage in working with
ELECTRONICS terms

6500

clear-cut definitions
and reference data.

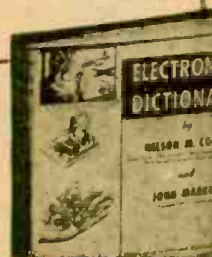

Just Out!

ELECTRONICS DICTIONARY

By NELSON M. COOKE, Lt. Com. USN
Executive Officer, Radio Materiel School,
Naval Research Laboratory, Washington, D. C.
and JOHN MARKUS

Associate Editor, Electronics

433 pages, 5 3/4 x 8 3/4, over 600 illustrations, \$5.00

An authoritative work to clarify and define the many new terms in use with the vast growth of electronics and electrical engineering—thorough, extensive and generously illustrated.

Fully covers terminology, principles, processes, equipment, abbreviations, colloquialisms in

Radio	Medical Electronics
Television	Electronic Heating and
Industrial Electronics	Welding
Sound Recording	Facsimile
Communications	Electronic Motor Control
Photoelectric Controls,	Long-distance Telegraph
Safety Devices, and	and Telephone
Intrusion Detectors	

10 days' FREE examination—send coupon

McGraw-Hill Book Co., 330 W. 42nd St., New York 18
Send me Cooke and Markus' **ELECTRONICS DICTIONARY**
for 10 days' examination, on approval. In 10 days I will
send \$5.00, plus few cents postage, or return book post-
paid. (Postage paid on cash orders.)

Name
Address
City and State
Company
Position RC 1-46
In Canada: mail to Embassy Book Company
12 Richmond St. E. Toronto 1

MATHEMATICS FOR RADIO

Two volumes, prepared for home study.
Book I (314 pp.) covers the algebra,
arithmetic, and geometry; Book II (329
pp.) covers the advanced algebra, trigo-
nometry, and complex numbers neces-
sary to read technical books and articles
on radio.

MAEDEL PUBLISHING HOUSE Room 117
593 East 38 Street, Brooklyn, New York

Send me **MATHEMATICS FOR RADIO AND
COMMUNICATION** as checked below. I enclose
payment therefor with the understanding that
I may return the book(s) within 5 days in good
condition and my money will be refunded.

Name

Address

- Book I at \$3.75 plus 6c postage
 Book II at \$4.00 plus 6c postage
 Books I and II at \$7.75 postage prepaid

Foreign and Canadian prices 25c per volume higher

FOR
PORTABLE RADIOS

BURGESS BATTERIES

RECOGNIZED BY THEIR
STRIPES • REMEMBERED
BY THEIR SERVICE

FREE
TO
RADIO
MEN

COLOR CODE and OHMS LAW CALCULATOR

Burstein-Applebee of Kansas City
offers you this great convenience
FREE. Easy to work. Solves many
problems in a jiffy. **FREE** to radio
men, electronic engineers and others
in the business. Attach coupon to
your letterhead.

MAIL COUPON NOW

BURSTEIN-APPLEBEE CO.
1012 McGEE, KANSAS CITY 6, MO.
Send me **FREE** Color Code and Ohms Law Cal-
culator along with latest catalog.

I am _____
STATE CONNECTION IN INDUSTRY

NAME _____

ADDRESS _____

TOWN _____

STATE _____

RADIO SCHOOL DIRECTORY

PREPARE NOW FOR SKILLED JOBS IN RADIO AND ELECTRONICS
MAKE a place for yourself in a new world of radio and electronics—a world in which revolutionary electronic developments will require highly specialized technical knowledge. Take a good course now to fit yourself for a good paying job. The training you need can be supplied by one of the schools advertised in this publication.

RADIO

Train with professionals. Complete, intensified courses; Repair & Maintenance, Communications, High-speed telegraphy, Slip transcription, FCC exams, etc. High School Students accepted for training as Merchant Marine Radio Officers. Gov't sponsorship available to veterans.

"A Radio School managed by radio men."
 45 W. 45th St., Dept. RC, New York 19, N.Y.

MELVILLE RADIO INSTITUTE

RADIO ENGINEERING!

VETERANS can complete work here in shortest possible time. Special Prep. Dept. Also RE-FRESHER COURSES. Courses also in Civil, Electrical, Mechanical, Chemical, Aeronautical Engineering; Business Administration, Accounting, Secretarial Science. Tuition, living costs low. 62nd year. Cosmopolitan student body. Enter Jan., Mar., June, Sept. Catalog.

TRI-STATE COLLEGE 2218 Collins Ave. ANGOLA INDIANA

RCA INSTITUTES, Inc.

Offer thorough training courses in all technical phases of **Radio and Television**

VETERANS: RCA Institutes is approved under G. I. Bill of Rights. For Free Catalog Write Dept. RC-46

RCA INSTITUTES, Inc.
 A Radio Corporation of America Service
 75 VARICK STREET NEW YORK 13, N. Y.

Correspondence Courses in **RADIO and ELECTRICAL ENGINEERING**

ELECTRICAL ENGINEERING Get good grade electrical field. Prepare yourself at low cost for secure future. Modern simplified, you can understand quickly.

RADIO ENGINEERING Extra one course in radio. Publish address, photo-electric work. Train you to be super-service man, real vacuum tube technician. Servicemen needed badly. Diploma on completion. Tuition \$25, either course. Deferred payment plan. Get copies of school catalogs, student magazines, complete details. **SEND NOW!**

FREE LINCOLN ENGINEERING SCHOOL Box 931C-83 Lincoln, Nebr.

LORAN-RADIO NAVIGATION AID

(Continued from page 291)

a second loran line-of-position, and a loran fix.

In most series of loran equipment the displacement of the pedestals is measured by means of the time-markers placed on the traces by the electrical circuits within the indicator. In some models the markers are on the traces at all times, while in others they are removed during the pulse-matching process.

The radio waves coming from the transmitter parallel to the earth's surface are known as ground waves. Others travel upward, encountering electrified layers of the atmosphere known as the ionosphere; these will be reflected back to the earth if conditions are favorable, and will be known as sky waves. By daylight, most of the sky waves are absorbed by the ionosphere and seldom make their appearances on the loran indicator. Late afternoon and early morning are best for sky waves. The significant layer of the ionosphere effective on the radio frequencies used in loran is the "E" layer at a height of about 50 miles; there is also an "F" layer about 150 miles height, but this layer is not too reliable and is not

CODE SENDING SPEED RECEIVING SPEED

Be a "key" man. Learn how to send and receive messages in code by telegraph and radio. Commerce needs thousands of men for jobs. Good pay, adventure, interesting work. Learn at home quickly through famous Candler System. Write for FREE BOOK.

CANDLER SYSTEM CO.
 Dept. 3-A, Box 928, Denver 1, Colo., U.S.A.

RADIO COURSES

- RADIO OPERATING • CODE
- RADIO SERVICING — ELECTRONICS
- REFRIGERATION SERVICING

Personal Counseling Services for Veterans
 Write for Latest Trade & Technical Catalog

Y.M.C.A. TRADE & TECHNICAL SCHOOLS
 4 W. 64th Street New York City

COMMERCIAL RADIO INSTITUTE

A radio training center for twenty-four years.

RESIDENT COURSES ONLY

Broadcast, Service, Aeronautical, Television and Marine telegraphy classes now forming. Literature upon request. Veteran training. Classes now forming for mid-year term February 1st.

Dept. C, 38 West Biddle St., Baltimore 1, Md.

RADIO

RADIO Technician and Radio Communications courses. Register now for new classes starting first MONDAY of each month. Day and Evening Classes.

AMERICAN RADIO INSTITUTE
 101 West 63rd St., New York 23, N. Y.
 APPROVED UNDER GI BILL OF RIGHTS.

LEARN RADIO QUICKLY

Send for Free Information:
 "3 Ways to Learn Radio"

Approved for Training Veterans

WESTERN RADIO INSTITUTE
 1457 Glenarm, Denver 2, Colo.

RADIO-TELEVISION See Big Ad. Page 253

ENGINEERING & SERVICING

Now Training Veterans Under "G.I." Bill Prepare now for profitable career! ENTER AT ANY TIME. Residence school classes in Radio-Electronics Engineering, Broadcast & Television Engineering and Servicing. Write for FREE Booklet

Capitol Radio Engineering Institute
 Dept. RC-12, 3224 16th Street, N. W., Washington 10, D. C.

used in loran. Likewise, when several reflections between the ionosphere and earth occur, creating hop-waves, loran does not

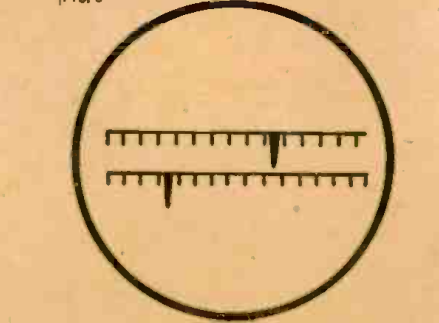

use them. Sky waves appear on the horizontal trace as "growing" and "receding" humps. Radio interference sometimes

makes them hard to keep on the scope, but the trained operator can usually handle them. The sky wave is good for 1,200 to 1,400 miles on fixes and even farther, under extreme noise conditions. Once identified, the sky wave is handled precisely the same as the ground wave. The first signal at the left end of the sweep (after the ground wave signal) is the E-wave hump. Others farther right are ignored. Since loran tables and charts are computed on ground wave bases, the corrections for sky waves are listed in the tables and on the charts. These corrections are pre-computed for station areas.

Loran receivers are susceptible to interference, which may be due to enemy jamming, transmitters aboard ship or on the shore, radio-telegraph, radiophone or radar. The receiver itself has a certain amount of inherent noise, known as "grass," but this normally has no serious effect on reception. A filter is provided on the loran receiver, and when cut in it eliminates much of the interference. Interference from radio transmissions aboard the vessel operating loran constitute the greatest handicap to its

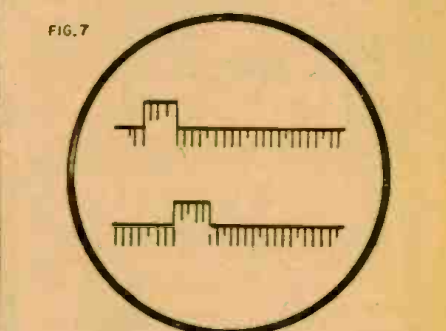

efficiency, but these can generally be controlled to allow loran reception.

Although still young—the first tests were made in 1942—loran has seen much service already. Evolved from television in that it represents a means of reproducing electric currents visually, loran was developed by the Radiation Laboratory of the National Defense Research Committee. First stations were set up on North Atlantic shores, and laboratory-built equipment was used. Experiments and manufacture of equipment progressed, and loran spanned great portions of the Pacific. (It is estimated that 70 station pairs in peacetime can service the world's sea areas.)

PUBLISHER DISCOVERS NEW ELECTRICAL DATA

Col. Robert McCormick, aging owner of the Chicago Tribune, is well-known to radio broadcast listeners as an authority on political and esthetic matters. It will come as no surprise to them that he has entered the field of electronic science, with revolutionary results. Discussing, among other things, the atom bomb, he said in a recent address over his broadcast station:

"I found a surprise in the speed of electricity. When I studied physics, it was taught that electricity moved with the speed of light. Now I find that electricity moves only at the rate of three and a half inches an hour, but that a wire is filled with electrons, as a pipe is filled with water, and when electrons are pushed in at one end of the wire, electrons are forced out the other end, so the effect is the same as when we believed electricity moved all the way from the generator to the motor with the speed of light."

The technical world will await with interest further discoveries of the learned colonel.



RCA's new television camera has a super-sensitive "eye" that sees even in the dimmest light—indoors or outdoors.

A television camera "with the eyes of a cat"

As a result of RCA research, television broadcasts will no longer be confined to brilliantly illuminated special studios—nor will outdoor events fade as the afternoon sun goes down.

For RCA Laboratories has perfected a new television camera tube, known as Image Orthicon. This tube, a hundred times more sensitive than other electronic "eyes," can pick up scenes lit by candlelight, or by the light of a single match!

This super-sensitive camera opens new fields for television. Operas, plays, ballets will be televised from their original performances in the darkened theater. Out-

door events will remain sharp and clear on your television set—until the very end! Television now can go places it could never go before.

From such research come the latest advances in radio, television, recording—all branches of electronics. RCA Laboratories is your assurance that when you buy any RCA product you become the owner of one of the finest instruments of its kind that science has achieved.

Radio Corporation of America, RCA Building, Radio City, New York 20. Listen to *The RCA Show*, Sundays, 4:30 P. M., Eastern Time, over NBC.



RCA Victor television receivers with clear, bright screens will reproduce every detail picked up by the RCA super-sensitive television camera. Lots of treats are in store for you. Even today, hundreds of people around New York enjoy regular weekly boxing bouts and other events over NBC's television station WNBT.



RADIO CORPORATION of AMERICA

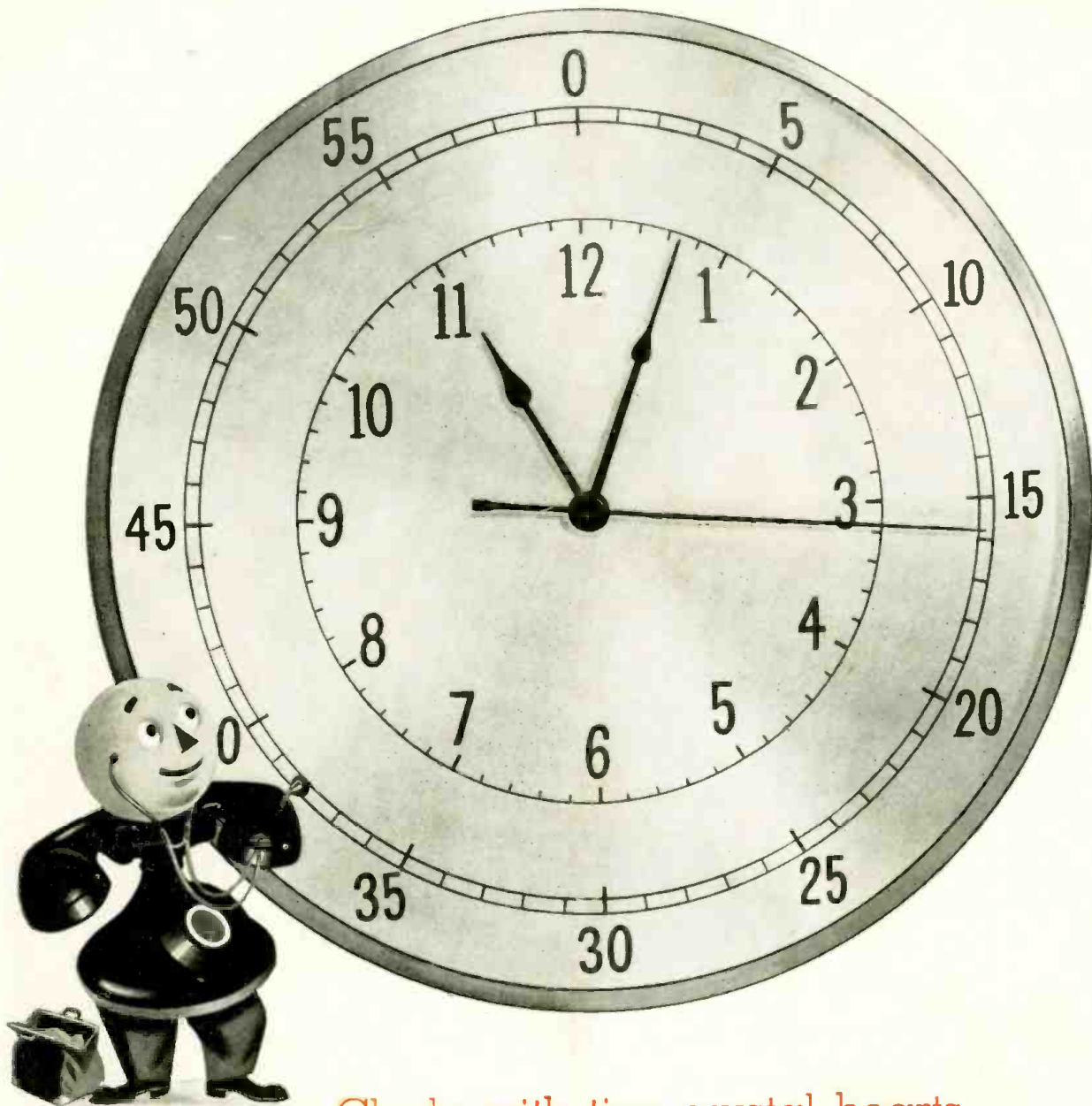

Clocks with tiny crystal hearts that beat 100,000 times a second

CRYSTAL HEARTS beat time in Bell Telephone Laboratories, and serve as standards in its electronics research. Four crystal clocks, without pendulums or escapements, throb their successive cycles without varying by as much as a second a year.

Precise time measurements may seem a far cry from Bell System telephone research, but time is a measure of frequency, and frequency is the foundation of modern communication, whether by land lines, cable, or radio.

These clocks are electronic devices developed by Bell Laboratories, and refined over years of research. Their energy is supplied through vacuum tubes, but the accurate timing, the controlling heart of the clock, is provided by a quartz crystal plate about the size of a postage stamp.

These crystal plates vibrate 100,000 times a second, but their contraction and expansion is submicroscopically small—less than a hundred-thousandth of an inch. They are in sealed boxes

to avoid any variation in atmospheric pressure, and their temperatures are controlled to a limit as small as a hundredth of a degree.

Bell Laboratories was one of the first to explore the possibilities of quartz in electrical communication, and its researches over many years enabled it to meet the need for precise crystals when war came. The same character of research is helping to bring ever better and more economical telephone service to the American people.



BELL TELEPHONE LABORATORIES Exploring and inventing, devising and perfecting for continued improvements and economies in telephone service.